



okvolight



Das Licht der Welt

CONTENTS

Point Light Source

4



Underground Light

46



Linear Light

24



Led Control System

48



Wall Washer

32

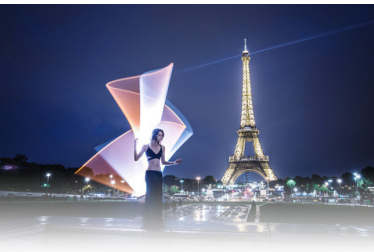

Accessories

54

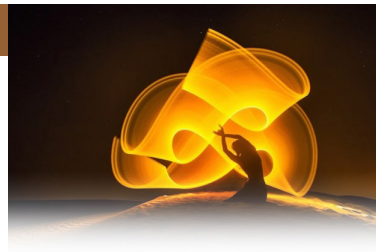

Bridge Light

42



Applications

60





OK Double Protection LED Point Light Source



Point Light Source



Product size: mm

OK Double Protection LED Point Light Source Technical Parameters

Production Technology: Double Protection

Average Lifespan: 50000hrs

Electrical Safety Class: III Class

Outdoor Weather Resistant: 10years

Outer Shell Fireproof Grade: V-0

Working Temperature: -20℃ -55℃

Protect Grade: IP68

Luminous Angle: 120°-180°

OK Double Protection LED Point Light Source Product Analysis

OK LED point lights, with Double Protection encapsulation technology, reach the highest Protect Grade IP68 and Fireproof Grade V-0, can be worked well underwater 20m and self-extinguish after leaving fire source.

The LED point lights can be controlled by offline machine to show RGB color (with SD card) , or transfer images, text, video and other signals on real-time online via computer.

OK Double Protection $\Phi 15$ LED Convex Point Light Source (Snap-in type)

CE FC IP68 Patented Product

Model: OK-DGC-15T



Product Size (mm)

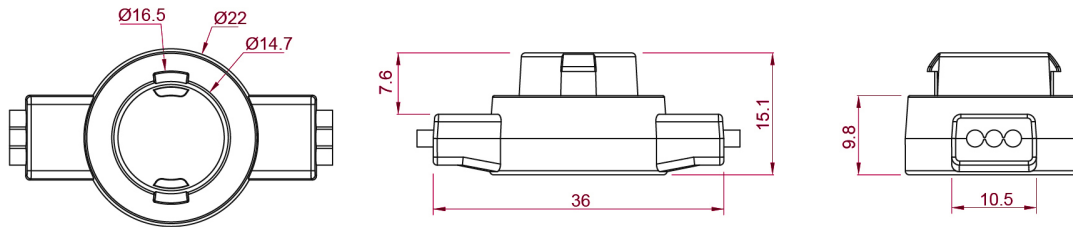

Applications

- ⊙ Draw the contour of buildings
- ⊙ Logos, signs and channel letters
- ⊙ Christmas tree decorative lights
- ⊙ Inner light source for outdoor lights
- ⊙ Outdoor advertising displays
- ⊙ Football stadium displays
- ⊙ Large stage background displays
- ⊙ Decorative lighting for public places

Specific Parameters

Product Model	Type	Control Method		Voltage	Power	Detailed Introduction
<i>OK-DGC-15T-CX1-1S-TP</i>	SMD	Serial shift	Digital Single Color	5V	0.3W	Single Color (1 Pc 5050SMD 3 in 1)
<i>OK-DGC-15T-CX1-3S-TP</i>	SMD		Digital RGB	5V	0.3W	RGB(1 Pc 5050SMD 3 in 1)

OK Double Protection $\Phi 20$ LED Point Light Source (Snap-in type)

CE FC IP68 Patented Product

Model: OK-DGC-20



Product Size (mm)

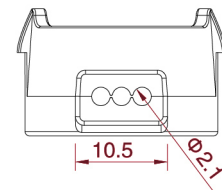
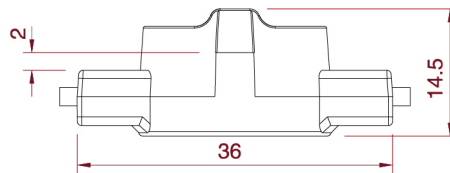
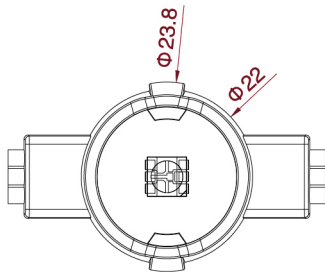

Applications

- Draw the contour of buildings
- Logos, signs and channel letters
- Christmas tree decorative lights
- Inner light source for outdoor lights
- Outdoor advertising displays
- Football stadium displays
- Large stage background displays
- Decorative lighting for public places of entertainment

Specific Parameters

Product Model	Type	Control Method		Voltage	Power	Detailed Introduction
<i>OK-DGC-20-CX1-1S-TP</i>	SMD	Serial shift	Digital Single Color	5V	0.3W	Single Color (1 Pc 5050SMD 3 in 1)
<i>OK-DGC-20-CX1-3S-TP</i>	SMD		Digital RGB	5V	0.3W	RGB(1 Pc 5050SMD 3 in 1)
<i>OK-DGC-20-CX1-3S-TP</i>	SMD		Digital RGB	5V	0.6W	RGB(2 Pc 3528SMD 3 in 1)

OK Double Protection $\Phi 20$ Underground LED Point Light Source (Snap-in type)

CE FC IP68 Patented Product

Model: OK-DGC-20DM

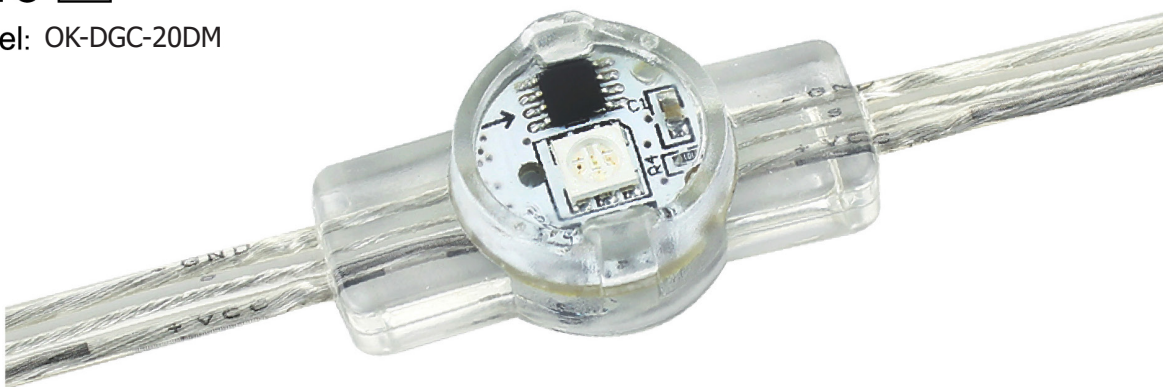

Product Size (mm)

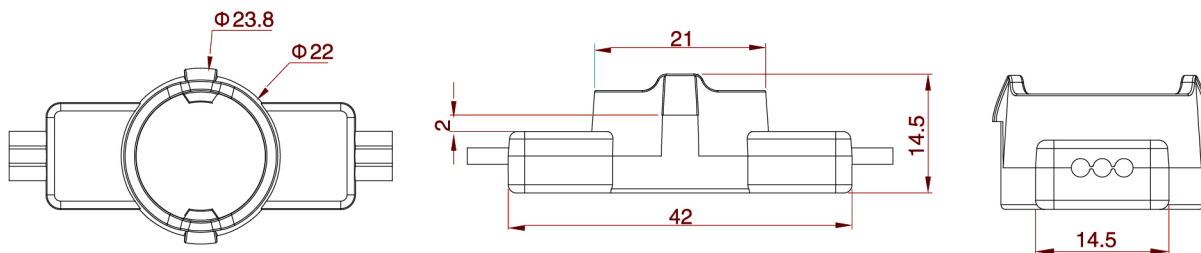

Applications

- ◎ Fountain lighting, waterfall lighting and underwater display
- ◎ Swimming pool decoration, plaza lighting

Specific Parameters

Product Model	Type	Control Method		Voltage	Power	Detailed Introduction
OK-DGC-20DM-CX1-1S-TP	SMD	Serial shift	Digital Single Color	5V	0.3W	Single Color (1 Pc 5050SMD 3 in 1)
OK-DGC-20DM-CX1-3S-TP	SMD		Digital RGB	5V	0.3W	RGB(1 Pc 5050SMD 3 in 1)
OK-DGC-20DM-CX1-3S-TP	SMD			5V	0.6W	RGB(2 Pcs 3528SMD 3 in 1)

OK Double Protection Φ 30 LED Point Light Source

CE FC IP68 Patented Product

Model: OK-DGC-30



Product Size (mm)

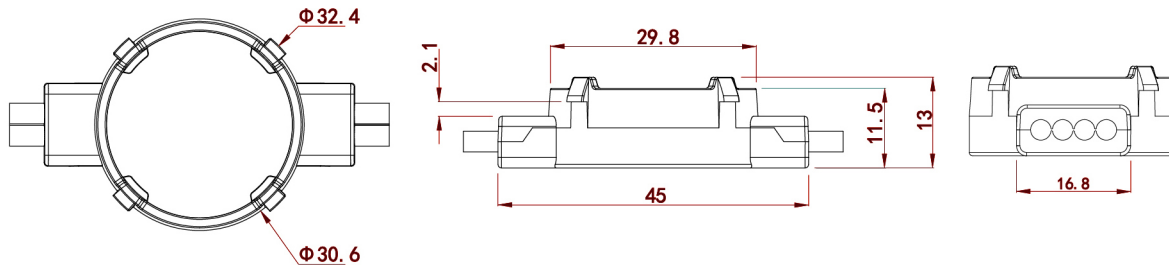

Applications

- Draw the contour of buildings
- City Logos, Sculptures
- Parade floats decorative lighting
- Indoor and outdoor advertising display
- Logos, Signs
- Draw the contour for letters, graphic
- Inner light source for various shape of lights.
- Indoor and outdoor decorative lighting, such as wall, ceiling, glass stair, etc.

Specific Parameters

Product Model	Type	Control Method		Voltage	Power	Detailed Introduction
OK-DGC-30-CL-TP	SMD	Normally on		12V	0.24W	3Pcs 3528 SMD
OK-DGC-30-CX2-1S-TP	SMD	Serial shift	Digital single color	12V	0.24W	Single Color (1 Pcs 5050SMD 3 in 1)
OK-DGC-30-CX2-3S-TP	SMD		Digital RGB	12V	0.72W	RGB(3 Pcs 5050SMD 3 in 1)

OK Double Protection $\Phi 30$ Convex LED Point Light Source

CE FC IP68 Patented Product

Model: OK-DGC-30T



Product Size (mm)

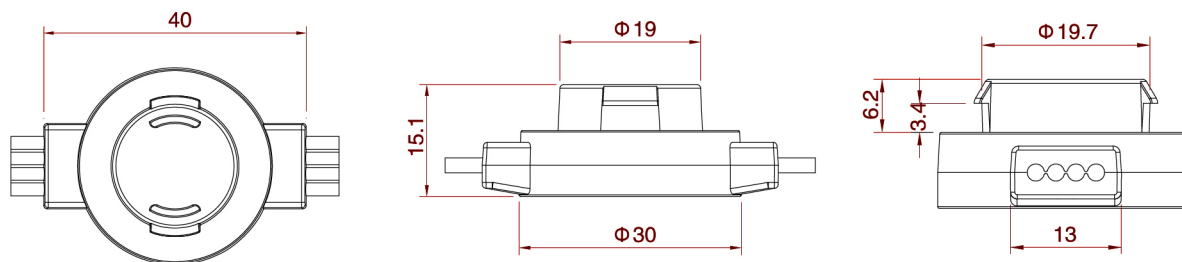

Applications

- ⊙ City Logos, Sculptures
- ⊙ Parade floats decorative lighting
- ⊙ Indoor and outdoor advertising display
- ⊙ Logos, Signs
- ⊙ Draw the contour for letters, graphic
- ⊙ Indoor and outdoor decorative lighting, such as wall ceiling, glass stair, etc

Specific Parameters

Product Model	Type	Control Method		Voltage	Power	Detailed Introduction
OK-DGC-30T-CX2-3S-TP	SMD	Serial shift	Digital RGB	12V	0.72W	RGB(3 Pcs 3535SMD 3 in 1)

OK Double Protection 30X30 LED Square Light Source

CE FC IP68 Patented Product

Model: OK-DGC-30X30



Product Size (mm)

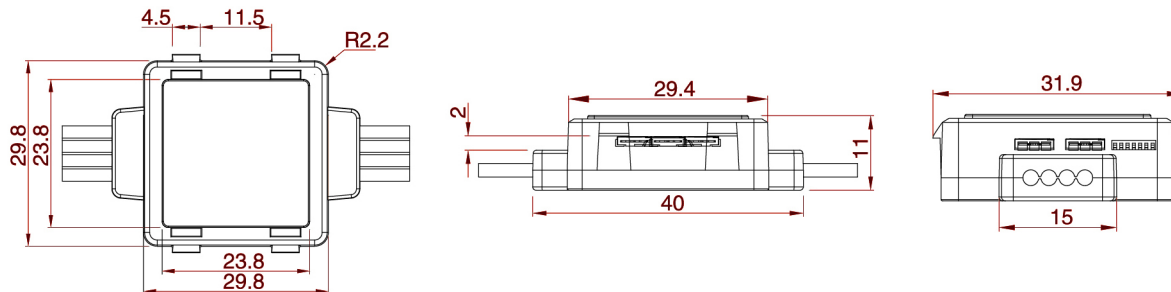

Applications

- Draw the contour of buildings
- City Logos, Sculptures
- Parade floats decorative lighting
- Indoor and outdoor advertising display
- Logos, Signs
- Draw the contour for letters, graphic
- Inner light source for various shape of lights
- Indoor and outdoor decorative lighting, such as wall, ceiling, glass stair, etc

Specific Parameters

Product Model	Type	Control Method		Voltage	Power	Detailed Introduction
OK-DGC-30X30-CX2-3S-TP	SMD	Serial shift	Digital RGB	12V	0.72W	RGB(3 Pcs 5050SMD 3 in 1)

OK Double Protection $\Phi 40$ LED Point Light Source

CE FC IP68 Patented Product

Model: OK-DGC-40



Product Size (mm)

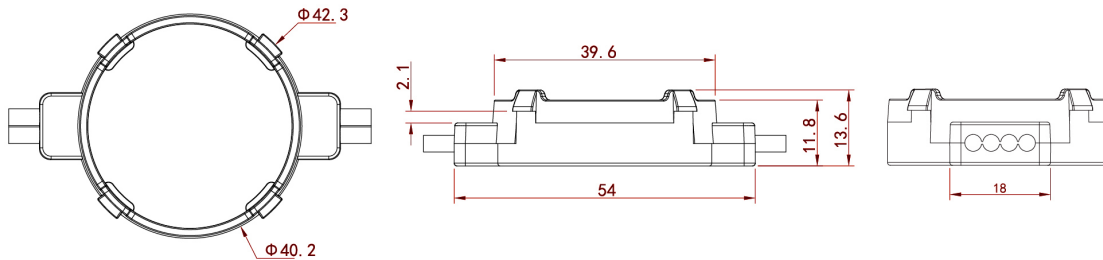

Applications

- Draw the contour of buildings, viaducts and bridges
- Display for glass ground square
- Decorative lighting for city square ground
- Ferris wheel lighting
- River way landscape lighting
- Outdoor advertising display, building display
- Logos, Signs and Channel Letters
- Historic building decorative lighting
- Decorative lighting for building top
- Draw the contour for letters, graphic
- Sculpture lighting

Specific Parameters

Product Model	Type	Control Method	Voltage	Power	Detailed Introduction	
OK-DGC-40-CL-TP	SMD	Normally on	12V	0.48W	6Pcs 3528 SMD	
OK-DGC-40-CX2-1S-TP	SMD	Serial shift	Digital single color	12V	0.72W	Single Color(3 Pcs 5050SMD)
OK-DGC-40-CX2-2S-TP	SMD		Digital double color	12V	0.48W	6Pcs 3528 SMD
OK-DGC-40-CX2-3S-TP	SMD		Digital RGB	12V	0.72W	RGB(3 Pcs 5050SMD 3 in 1)
OK-DGC-40-CX2-4S-TP	SMD		Digital RGBW	12V	0.96W	RGB(3 Pcs 5050SMD 3 in 1)/ 3 Pcs 3528SMD

OK Double Protection $\Phi 40$ Underground LED Point Light Source

CE FC IP68 Patented Product

Model: OK-DGC-40DM

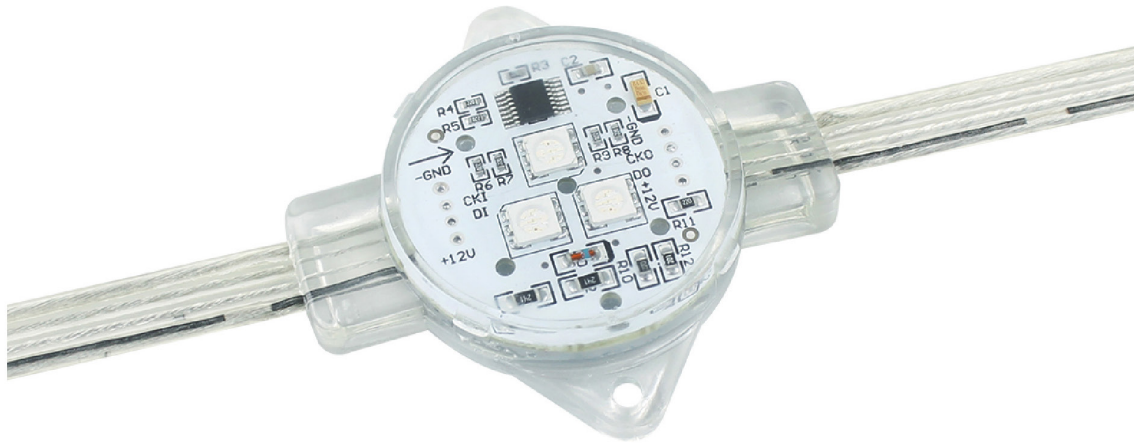

Product Size (mm)

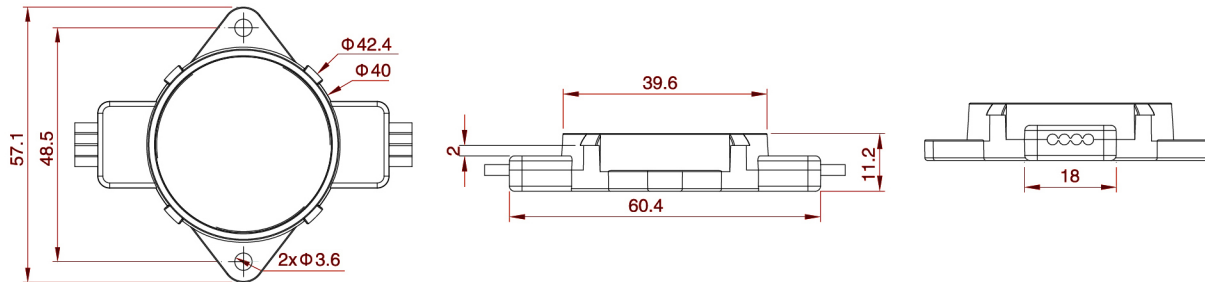

Applications

- ⊙ Fountain lights, waterfall light and underwater display
- ⊙ Swimming pool decoration lights, square underground lights

Specific Parameters

Product Model	Type	Control Method		Voltage	Power	Detailed Introduction
OK-DGC-40DM-CX1-1S-TP	SMD	Serial control Single Signal Line	Digital Single Color	12V	0.72W	Single Color (3 Pcs 5050SMD 3 in 1)
OK-DGC-40DM-CX1-3S-TP	SMD		Digital RGB	12V	0.72W	RGB(3 Pcs 5050SMD 3 in 1)

OK Double Protection 50X40 LED Square Light Source

CE FC IP68 Patented Product

Model: OK-DGC-50X40

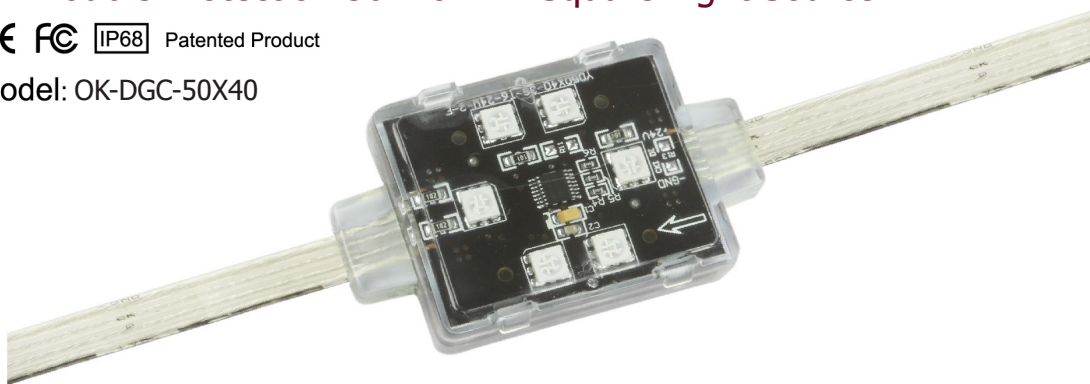

Product Size (mm)

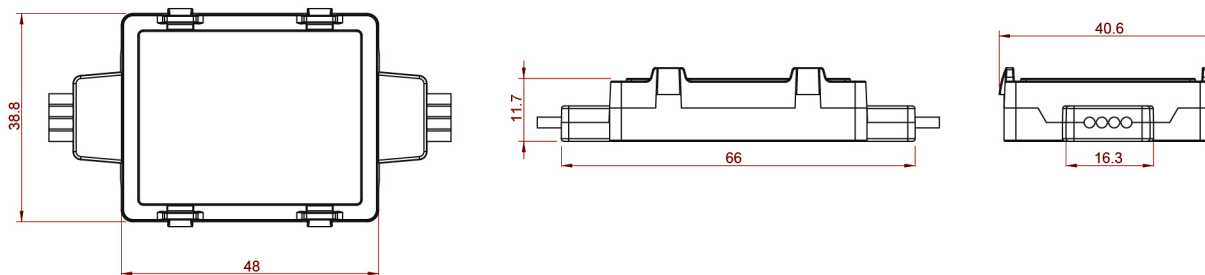

Applications

- Draw the contour of buildings
- City Logos, Sculptures
- Parade floats decorative lighting
- Indoor and outdoor advertising display
- Logos, Signs
- Draw the contour for letters, graphic
- Inner light source for various shape of lights
- Indoor and outdoor decorative lighting, such as wall, ceiling, glass stair, etc

Specific Parameters

Product Model	Type	Control Method		Voltage	Power	Detailed Introduction
OK-DGC-50X40-CX2-3S	SMD	Serial shift	Digital single color	24V	1.44W	RGB(6 Pcs 5050SMD 3 in 1)

OK Double Protection Φ 50 LED Point Light Source

CE FC IP68 Patented Product

Model: OK-DGC-50

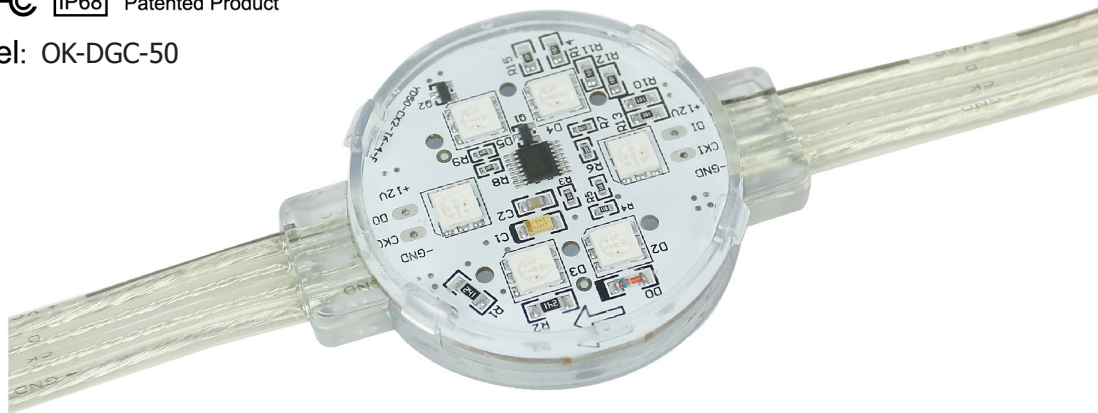

Product Size (mm)

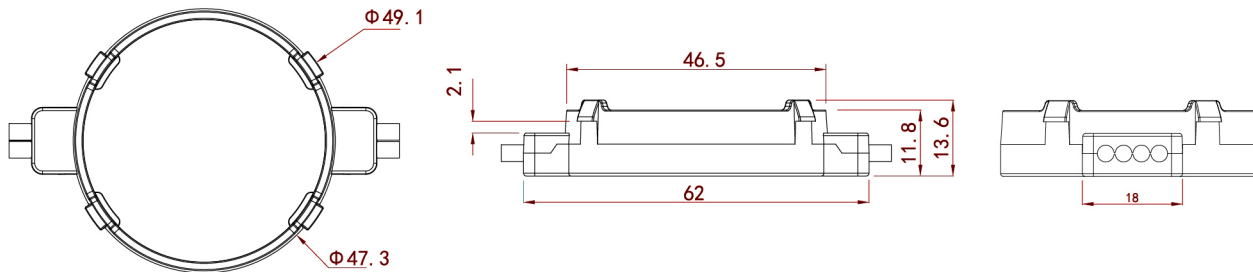

Applications

- ⊙ Draw the contour of buildings and bridges
- ⊙ Outdoor large scale advertising display and building display
- ⊙ Inner light source of logos
- ⊙ Swimming pool, fountain, aquarium and underwater landscape lighting
- ⊙ Inner side LED display for large scale curtain wall
- ⊙ Underground landscape lighting for park and garden

Specific Parameters

Product Model	Type	Control Method		Voltage	Power	Detailed Introduction
OK-DGC-50-CL-TP	SMD	Normally on		12V	0.72W	9Pcs LED Bulbs, Single Color: R,G,B,Y,W
OK-DGC-50-CX2-1S-TP	SMD		Digital single color	12V	0.72W	9Pcs 3528 SMD
OK-DGC-50-CX2-2S-TP	SMD		Digital double color	12V	0.96W	Single Color(12 Pcs 3528SMD)

OK Double Protection Φ 50 LED Point Light Source (could be removed from forward and backward)

CE FC IP68 Patented Product

Model: OK-DGC-50QH

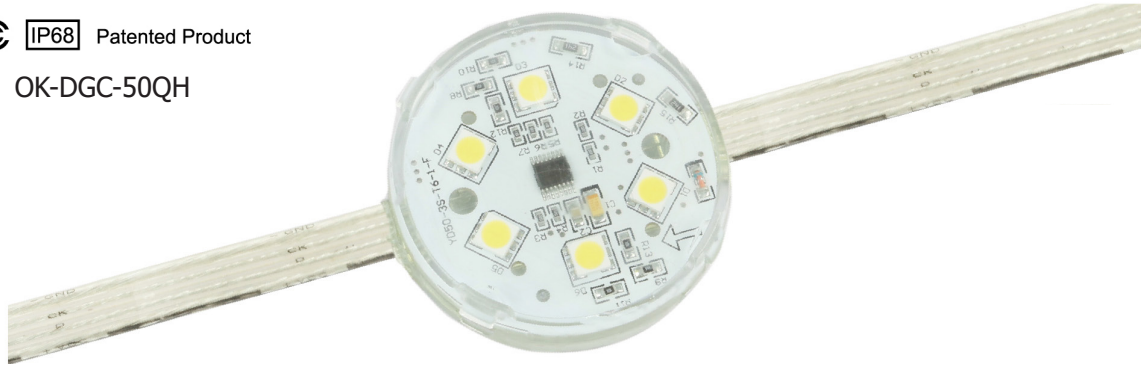

Product Size (mm)

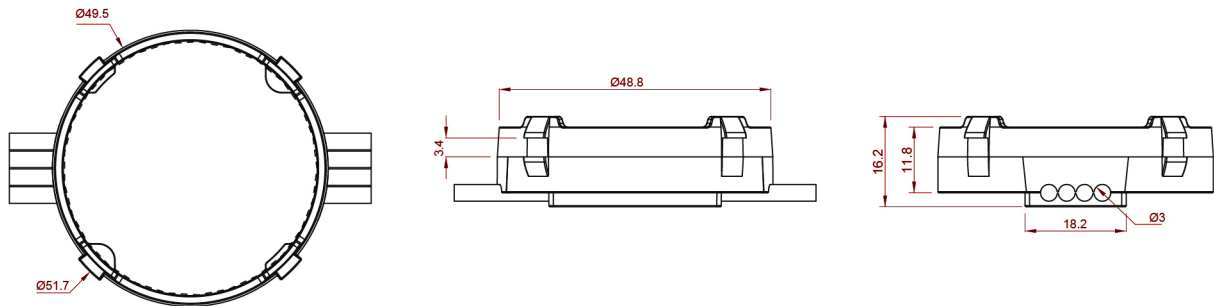

Applications

- ⊙ Draw the contour of large scale buildings and bridges
- ⊙ Outdoor large scale advertising display and building display
- ⊙ Inner light source of logos
- ⊙ Swimming pool, fountain, aquarium and underwater landscape lighting
- ⊙ Inner side LED display for large scale curtain wall
- ⊙ Underground landscape lighting for park and garden

Specific Parameters

Product Model	Type	Control Method		Voltage	Power	Detailed Introduction
OK-DGC-50QH-CX2-1S-TP	SMD	Serial shift	Digital single color	24V	1.44W	Single Color (6 Pc 5050SMD 3 in 1)
OK-DGC-50QH-CX2-3S-TP	SMD		Digital RGB	24V	1.44W	RGB(6 Pc 5050SMD 3 in 1)

OK Double Protection $\Phi 60$ LED Point Light Source

CE FC IP68 Patented Product

Model: OK-DGC-60



Product Size (mm)

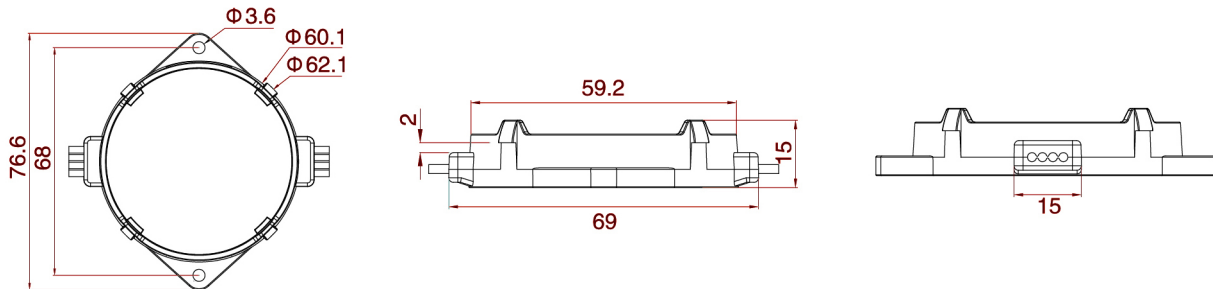

Applications

- Draw the contour of large scale buildings and bridges
- Outdoor large scale advertising display and building display
- Inner light source of logos
- Swimming pool, fountain, aquarium and underwater landscape lighting
- Inner side LED display for large scale curtain wall
- Underground landscape lighting for park and garden

Specific Parameters

Product Model	Type	Control Method		Voltage	Power	Detailed Introduction
OK-DGC-60-CL-TP	SMD	Normally on		24V	1.44W	18Pcs 3528 SMD
OK-DGC-60-CL-TP	SMD			24V	1.44W	Single Color (12 Pcs 5050SMD 3 in 1)
OK-DGC-60-CX2-1S-TP	SMD	Serial control Two Signal Lines	Digital single color	24V	2.88W	Single Color (12 Pcs 5050SMD 3 in 1)
OK-DGC-60-CX2-3S-TP	SMD		Digital RGB	24V	2.88W	RGB(12 Pcs 5050 SMD 3 in 1)

OK Double Protection $\Phi 60$ Underground LED Point Light Source

CE FC IP68 Patented Product

Model: OK-DGC-60DM



Product Size (mm)

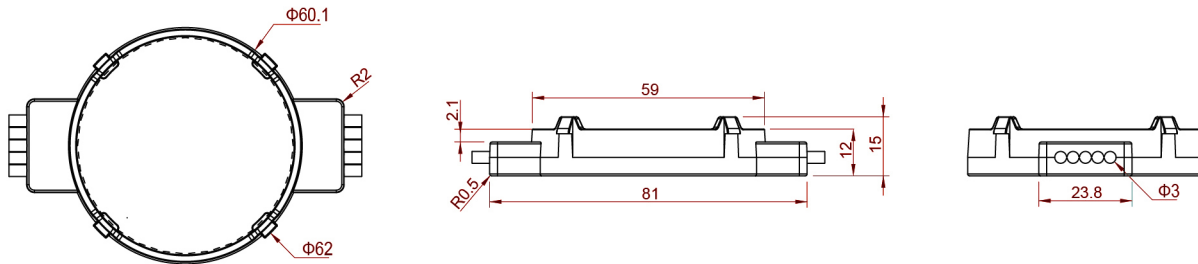

Applications

- ⊙Fountain lights, waterfall light and underwater display
- ⊙Swimming pool decoration lights, square underground lights

Specific Parameters

Product Model	Type	Control Method		Voltage	Power	Detailed Introduction
OK-DGC-60-CL-TP	SMD	Normally on		24V	1.44W	18Pcs 3528 SMD
OK-DGC-60-CL-TP	SMD			24V	1.44W	Single Color (12 Pcs 5050SMD 3 in 1)
OK-DGC-60-CX2-1S-TP	SMD	Serial control Two Signal Lines	Digital single color	24V	2.88W	Single Color (12 Pcs 5050SMD 3 in 1)
OK-DGC-60-CX2-3S-TP	SMD		Digital RGB	24V	2.88W	RGB(12 Pcs 5050 SMD 3 in 1)

OK Double Protection Φ 90 LED Point Light Source

CE FC IP68 Patented Product

Model: OK-DGC-90



Product Size (mm)

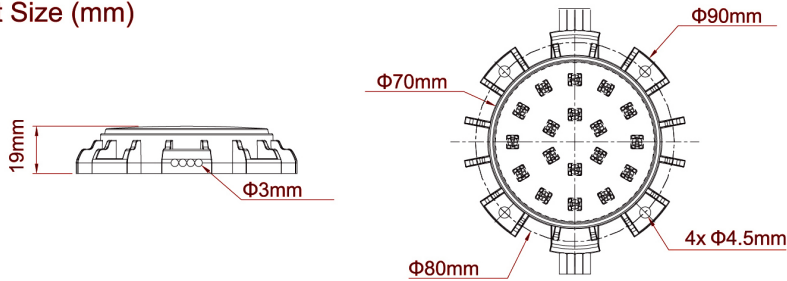

Applications

- Buildings curtain wall node lighting
- River way, river side landscape lighting
- Underwater landscape lighting, such as waterfall, fountain and swimming pool
- Road greening decoration lighting
- Underground lights, lawn lights, garden lights, wall lights
- Decorative lighting for building

Specific Parameters

Product Model	Type	Control Method	Voltage	Power	Detailed Introduction	
OK-DGC-90-CL-TP	SMD	Normally on	24V	1.92W	24 Pcs 3528SMD	
OK-DGC-90-CL-TP	SMD		24V	1.44W	12 Pcs 5050SMD 3 in 1	
OK-DGC-90-CX1-1S-TP	SMD	Serial shift	Digital single color	24V	2.88W	12 Pcs 5050SMD 3 in 1
OK-DGC-90-CX2-2S-TP	SMD		Digital double color	24V	1.92W	24 Pcs 3528SMD
OK-DGC-90-CX2-3S-TP	SMD		Digital RGB	24V	4.32W	RGB(18 Pcs 5050SMD 3 in 1)
OK-DGC-90-CX2-4S-TP	SMD		Digital RGB	24V	5.76W	RGB(18 Pcs 5050SMD 3 in 1)/ 18 Pcs 3528SMD
OK-DGC-90-DMX-3S-TP	SMD		Digital RGB	24V	4.32W	RGB(18 Pcs 5050SMD 3 in 1)
OK-DGC-90-DMX-4S-TP	SMD	DMX512	Digital RGB	24V	5.76W	RGB(18 Pcs 5050SMD 3 in 1)/ 18 Pcs 3528SMD

OK Double Protection $\Phi 120$ LED Point Light Source

CE FC IP68 Patented Product

Model: OK-DGC-120

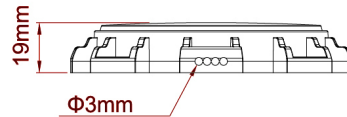
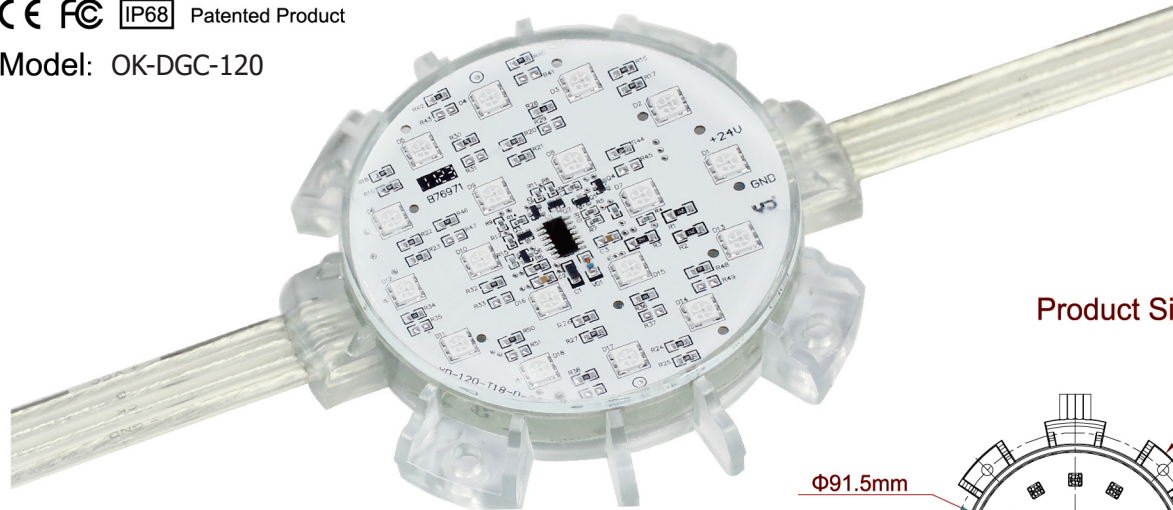

Product Size (mm)

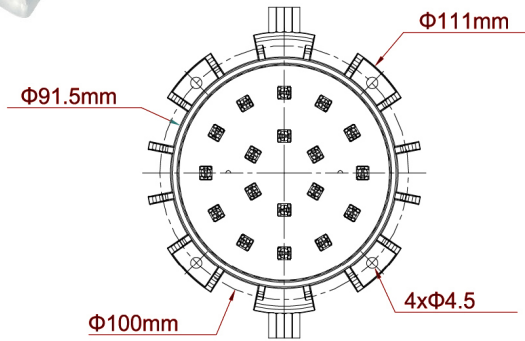

Applications

- ⊙ Buildings curtain wall node lighting
- ⊙ River way, river side landscape lighting
- ⊙ Underwater landscape lighting, such as waterfall, fountain and swimming pool
- ⊙ Road greening decoration lighting
- ⊙ Underground lights, lawn lights, garden lights, wall lights
- ⊙ Decorative lighting for building

Specific Parameters

Product Model	Type	Control Method		Voltage	Power	Detailed Introduction
OK-DGC-120-CL-TP	SMD	Normally on		24V	2.88W	36 Pcs 3528 SMD
OK-DGC-120-CL-TP	SMD			24V	2.16W	Single Color (18 Pcs 5050SMD 3 in 1)
OK-DGC-120-CX2-1S-TP	SMD	Serial shift	Digital single color	24V	4.32W	18 Pcs 5050SMD
OK-DGC-120-CX2-2S-TP	SMD		Digital double color	24V	2.88W	36 Pcs 3528SMD
OK-DGC-120-CX2-3S-TP	SMD		Digital RGB	24V	4.32W	RGB(18 Pcs 5050SMD 3 in 1)
OK-DGC-120-CX2-4S-TP	SMD		Digital RGB	24V	5.76W	RGB(18 Pcs 5050SMD 3 in 1)/ 18 Pcs 3528SMD
OK-DGC-120-DMX-3S-TP	SMD	DMX512	Digital RGB	24V	4.32W	RGB(18 Pcs 5050SMD 3 in 1)
OK-DGC-120-DMX-4S-TP	SMD		Digital RGB	24V	5.76W	RGB(18 Pcs 5050SMD 3 in 1)/ 18 Pcs 3528SMD

OK Double Protection 50X100 LED Square Light Source

CE FC IP68 Patented Product

Model: OK-DGC-50X100

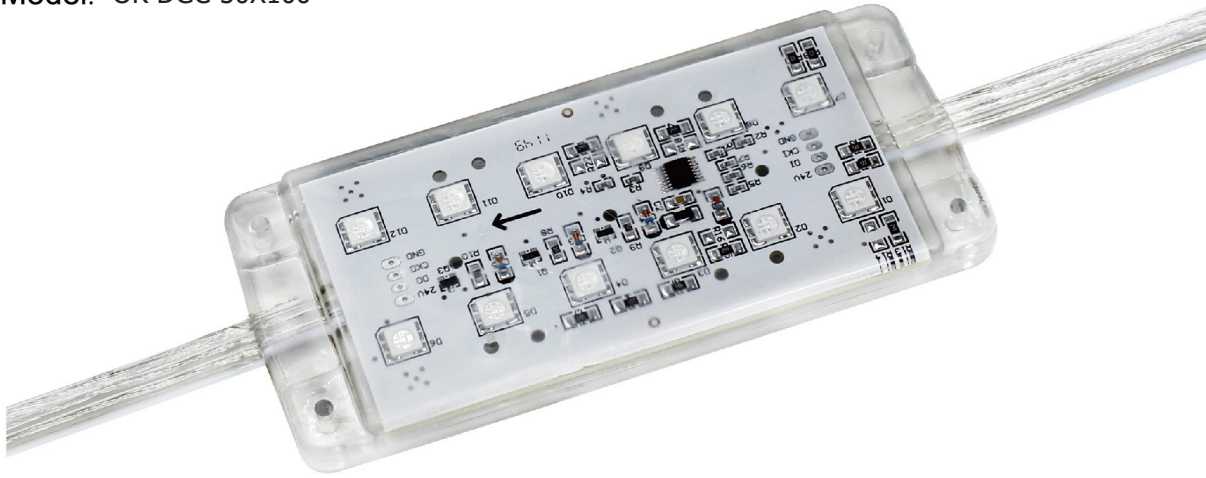

Product Size (mm)

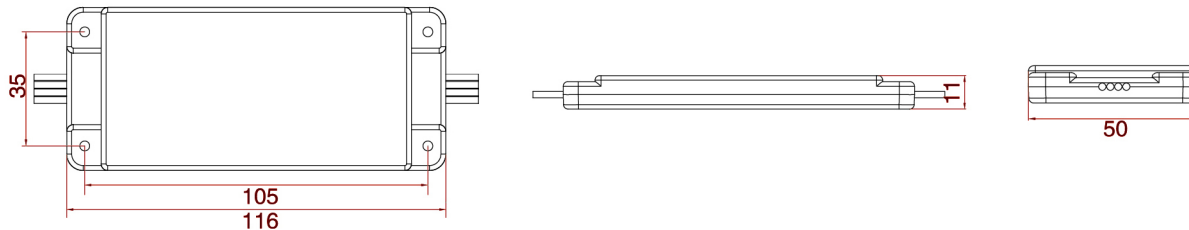

Applications

- Bridge stay cable
- Draw the contour for large scale buildings
- River way, river landscape lighting
- Historic building lighting
- Display for glass ground square

Specific Parameters

Product Model	Type	Control Method		Voltage	Power	Detailed Introduction
OK-DGC-50X100-CL-TP	SMD	Normally on		24V	1.92W	24Pcs 3528 SMD
OK-DGC-50X100-CX2-3S-TP	SMD	Serial shift	Digital RGB	24V	2.88W	RGB(12 Pcs 5050 SMD 3 in 1)

OK Double Protection 16X60 LED Square Light Source

CE FC IP68 Patented Product

Model: OK-XT-25DM



Product Size (mm)

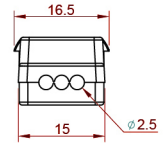
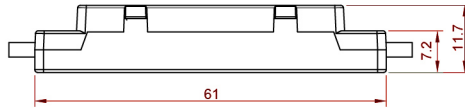
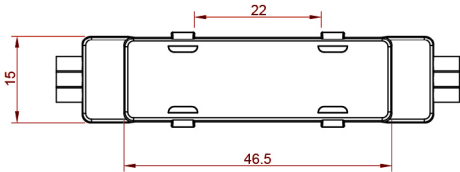

Applications

- Draw the contour of buildings
- City Logos, Sculptures
- Parade floats decorative lighting
- Indoor and outdoor advertising display
- Logos, Signs
- Draw the contour for letters, graphic
- Inner light source for various shape of lights

Specific Parameters

Product Model	Type	Control Method		Voltage	Power	Detailed Introduction
OK-DGC-16X60-CX1-15-TP	SMD	Serial shift	Digital single color	12V	0.72W	3 Pcs 5050SMD
OK-DGC-16X60-CX1-3S-TP	SMD		Digital RGB	12V	0.72W	RGB(3 Pcs 5050SMD 3 in 1)

OK Double Protection XT-25 Underground LED Linear Light Source

CE FC IP68 Patented Product

Model: OK-XT-25DM



Product Size (mm)

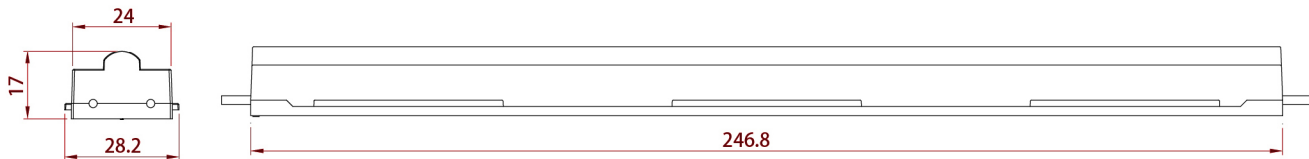

Applications

- ⊙ Light source of normally on linear light
- ⊙ Underground light source
- ⊙ Cabinet & refrigerator inside lighting
- ⊙ Underwater landscape lighting such as waterfall, fountain, swimming pool

Specific Parameters

Product Model	Type	Control Method	Voltage	Power	Detailed Introduction
OK-XT-25DM-CL-CJ	DIP	Normally on	24V	1.92W	24Pcs LED Bulbs, Single Color: R,G,B,Y,W



OK Double Protection LED Linear Light



Linear Light



OK-CBXT-15



OK-CZXT-15



OK-CZXT-25



OK-CLXT-28



OK-CLXT-40



OK-CZXT-35

Product size: mm

OK Double Protection LED Linear Light Technical Parameters

Production Technology: Double Protection

Electrical Safety Class: III Class

Outer Shell Fireproof Grade: V-0

Protect Grade: IP68

Average Lifespan: 50000hrs

Outdoor Weather Resistant: 10years

Working Temperature: -20℃ -55℃

Luminous Angle: 120°-180°

OK Double Protection LED Linear Light Product Analysis

OK LED linear lights are integrated design of Double Protection linear light source and the special aluminum base with single or double row light source structure. The lights with the wire groove are convenient for the installation. It hardly influences the daytime effect of the building.

The LED Linear lights can directly show single color (normally on), also can be controlled by offline machine (with SD card) to show RGB color, or transfer images, text, video and other signals on real-time online via computer.

OK Ultra Thin Aluminum LED Linear Light (Built in Double Protection XT-15 Linear Light Source)

CE FC IP68 Patented Product

Model: OK-CBXT-15



Product details



Product Size (mm)

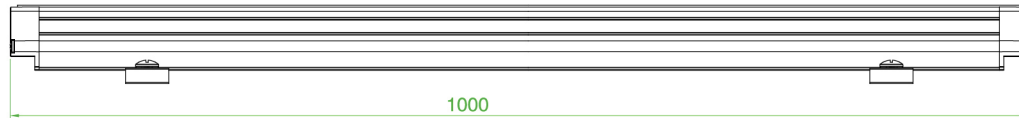
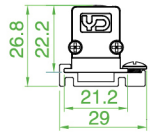

Applications

- ⊙ Draw the contour of building, viaduct and bridge
- ⊙ Park, garden and landscape lighting
- ⊙ River way, river side landscape lighting
- ⊙ Building facade, large-scale display of curtain wall
- ⊙ Historic Building decorative lighting
- ⊙ Decorative lighting for building top

Specific Parameters

Product Model	Type	Control Method		Voltage	Power	Detailed Introduction
OK-CBXT-15-CL-TP	SMD	Normally on		24V	7.68W	96 Pcs 3528 SMD
OK-CBXT-15-CX1-1S-TP	SMD	Serial shift	Digital single color	12V	8.64W	Single Color(36 Pcs 5050SMD 3 in 1) 12Pcs/4Pcs Pixel Lights in each meter
OK-CBXT-15-CX1-3S-TP	SMD		Digital RGB	12V	8.64W	RGB(36 Pcs 5050SMD 3 in 1) 12Pcs/4Pcs Pixel Lights in each meter
OK-CBXT-15-CX1-3S-TP	SMD			24V	11.52W	RGB(48 Pcs 5050SMD 3 in 1) 8Pcs Pixel Lights in each meter

OK Ultra Narrow Aluminum LED Linear Light (Built in Double Protection XT-15 Linear Light Source)

CE FC IP68 Patented Product

Model: OK-CZXT-15



Product Size (mm)

Product details

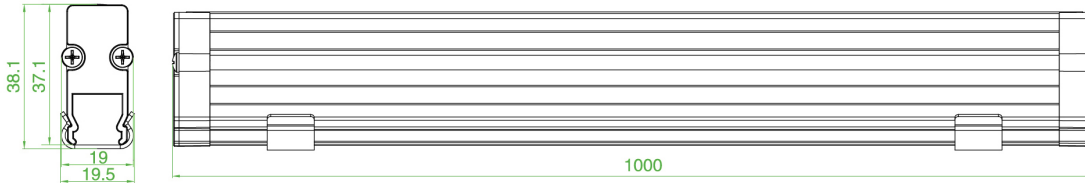

Applications

- ⊙ Draw the contour of building, viaduct and bridge
- ⊙ Park, garden and landscape lighting
- ⊙ River way, river side landscape lighting
- ⊙ Building facade, large-scale display of curtain wall
- ⊙ Historic Building decorative lighting
- ⊙ Decorative lighting for building top

Specific Parameters

Product Model	Type	Control Method		Voltage	Power	Detailed Introduction
OK-CZXT-15-CL-TP	SMD	Normally on		24V	7.68W	96 Pcs 3528 SMD
OK-CZXT-15-CX1-1S-TP	SMD	Serial shift	Digital single color	12V	8.64W	Single Color(36 Pcs 5050SMD 3 in 1) 12Pcs/4Pcs Pixel Lights in each meter
OK-CZXT-15-CX1-3S-TP	SMD		Digital RGB	12V	8.64W	RGB(36 Pcs 5050SMD 3 in 1) 12Pcs/4Pcs Pixel Lights in each meter
OK-CZXT-15-CX1-3S-TP	SMD			24V	11.52W	RGB(48 Pcs 5050SMD 3 in 1) 8Pcs Pixel Lights in each meter

OK Ultra Narrow Aluminum LED Linear Light (Built in Double Protection XT-25 Linear Light Source)

CE FC IP68 Patented Product

Model: OK-CZXT-25

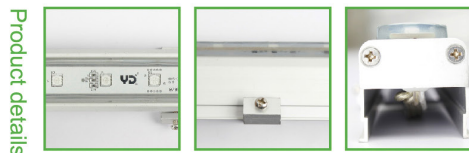

Product Size (mm)

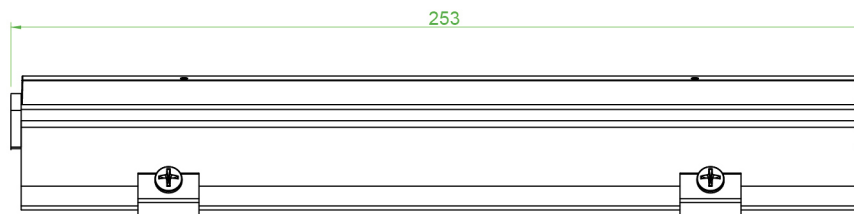
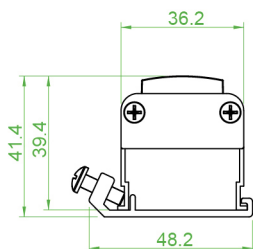

Applications

- ⊙ Draw the contour of building, viaduct and bridge
- ⊙ Park, garden and landscape lighting
- ⊙ River way, river side landscape lighting
- ⊙ Historic Building decorative lighting
- ⊙ Building top decorative lighting
- ⊙ Humid occasions lighting, such as underground, lake side and swimming pool

Specific Parameters

Product Model	Type	Control Method		Voltage	Power	Detailed Introduction
OK-CZXT-25-CL-TP	SMD	Normally on		24V	7.68W	96Pcs 3528 SMD
OK-CZXT-25-CX1-1S-TP	SMD	Serial shift	Digital single color	24V	8.64W	Single Color (36 Pcs 5050SMD 3 in 1)
OK-CZXT-25-CX1-3S-TP	SMD		Digital RGB	12V	8.64W	RGB(36 Pcs 5050SMD 3 in 1)

OK Ultra Narrow Aluminum LED Linear Light (Built in Double Protection XT-28 Linear Light Source)

CE FC IP68 Patented Product

Model: OK-CZXT-28



Product details

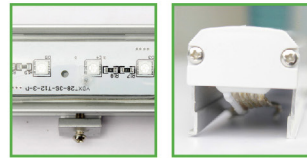

Product Size (mm)

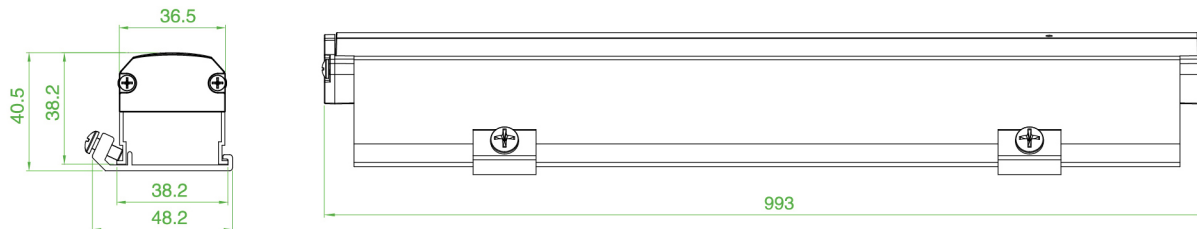

Applications

- ◎ Draw the outline of buildings, viaducts and bridges
- ◎ Lighting projects of parks, gardens and scenic
- ◎ Lighting projects of river-channel and river-bank
- ◎ Apply in some humid environments like underground, lake-bank, swimming pool etc

Specific Parameters

Product Model	Type	Control Method	Voltage	Power	Detailed Introduction
OK-CZXT-28-DMX-3S-TP	SMD	DMX512	24V	11.52W	RGB(48 Pcs 5050 SMD 3 in 1)

OK Double Row & Ultra Bright Aluminum LED Linear Light (Built in Double Protection XT-40 Linear Light Source)

CE FC IP68 Patented Product

Model: OK-CLXT-40



Product details

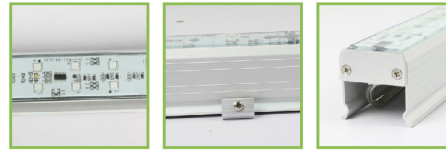

Product Size (mm)

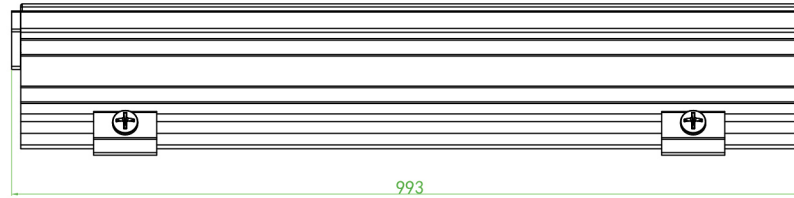
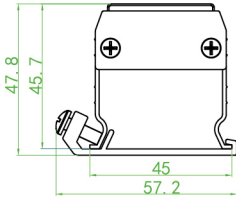

Applications

- ⊙ Draw the contour of building, viaduct and bridge
- ⊙ Park, garden and landscape lighting
- ⊙ River way, river landscape lighting
- ⊙ Historic Building decorative lighting
- ⊙ Building top decorative lighting
- ⊙ Humid occasions lighting, such as underground lake side and swimming pool

Specific Parameters

Product Model	Type	Control Method		Voltage	Power	Detailed Introduction
<i>OK-CLXT-40-CX1-1S-TP</i>	SMD	Serial shift	Digital single color	24V	15.36W	Single Color (72 Pcs 5050SMD 3 in 1)
<i>OK-CLXT-40-CX1-3S-TP</i>	SMD		Digital RGB	24V	15.36W	RGB(72 Pcs 5050SMD 3 in 1)
<i>OK-CLXT-40-DMX-3S-TP</i>	SMD	DMX512	Digital RGB	24V	17.28W	RGB(72 Pcs 5050SMD 3 in 1)

OK Ultra Narrow Aluminum LED Linear Light (Built in Double Protection 55-35 Square Light Source)

CE FC IP68 Patented Product

Model: OK-CZXT-35



Product details

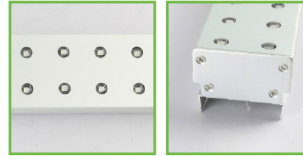

Product Size (mm)

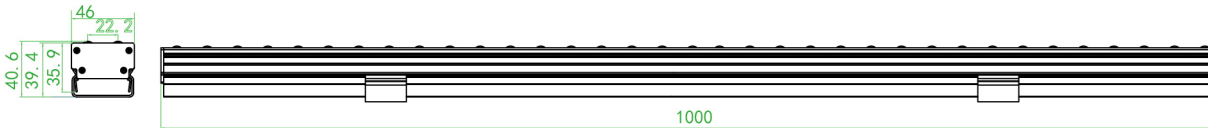

Applications

- Draw the contour of building, viaduct and bridge.
- Park, garden and landscape lighting
- River way, river landscape lighting
- Building top decorating lighting

Specific Parameters

Product Model	Type	Control Method		Voltage	Power	Detailed Introduction
OK-CZXT-35-CX1-1S-TP	SMD	Serial shift	Digital RGB	24V	21.6W	RGB(90Pcs 5050SMD 3 in 1)



OK Double Protection LED Wall Washer



Wall Washer



OK-BT-25



OK-BT-40



OK-BTG-18



OK-BTG-25



OK-BTG-40



OK-BTG-50G



OK-BTG-60



OK-BTY-45

Product size: mm

OK Double Protection LED Wall Washer Technical Parameters

Production Technology: Double Protection

Average Lifespan: 50000hrs

Electrical Safety Class: III Class

Outdoor Weather Resistant: 10years

Outer Shell Fireproof Grade: V-0

Working Temperature: -20℃-55℃

Protect Grade: IP68

OK Double Protection LED Wall Washer Product Analysis

OK LED wall washer, built-in Double Protection linear light source, protect grade IP68, the aluminum outer shell and light barrier structure, single, double or three row lights source design, could meet the customer's different requirements of wall-washing height.

OK BT-25 LED Wall Washer (Built in Double Protection XT-25 Linear Light Source)

CE FC IP68 Patented Product

Model: OK-BT-25



Product Size (mm)

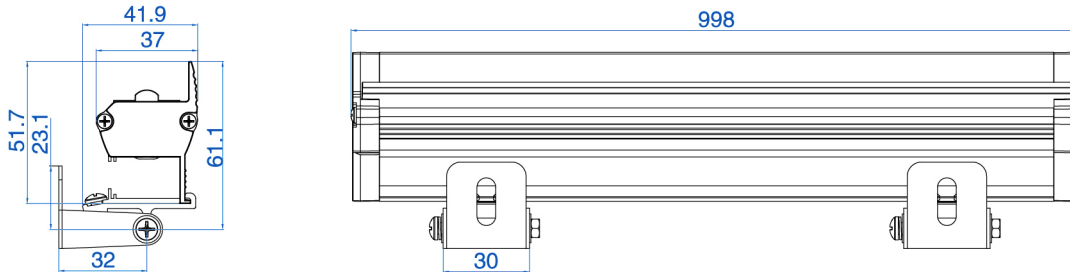

Applications

- Wall washer for building and bridge
- Park, plaza steps lighting
- River way, bridge guardrail lighting
- Swimming pool, fountain
- Airport, subway, overpass, landmark lighting
- Inner wall washer of building
- Individual building, historical building group lighting

Specific Parameters

Product Model	Type	Control Method	Voltage	Power	Detailed Introduction
OK-BT-25-CL-CJ	DIP	Normally on	24V	7.68W	96Pcs LED Bulbs, Single Color: R,G,B,Y,W,BG,SKY,GLD
OK-BT-25-CL-TP	SMD		24V	7.68W	96Pcs 3528 SMD
OK-BT-25-CL-TP	SMD		12V	4.32W	Single Color (36 Pcs 5050SMD 3 in 1)
OK-BT-25-CX1-1S-CJ	DIP	Serial control Single Signal Line	24V	7.68W	96Pcs LED Bulbs, Single Color: R,G,B,Y,W
OK-BT-25-CX1-1S-TP	SMD				
OK-BT-25-CX1-3S-CJ	DIP		12V	8.64W	R36G36B36
OK-BT-25-CX1-3S-TP	SMD				

OK BT-40 LED Wall Washer (Built in Double Protection XT-40 Linear Light Source)

CE FC IP68 Patented Product

Model: OK-BT-40



Product Size (mm)

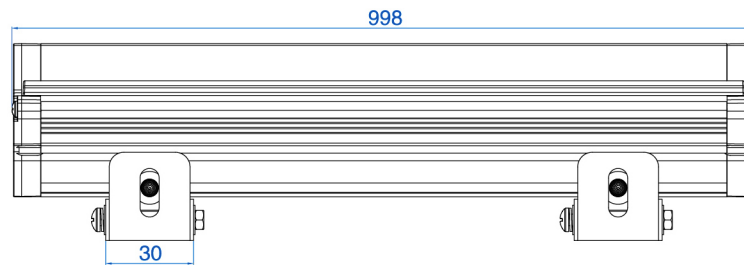
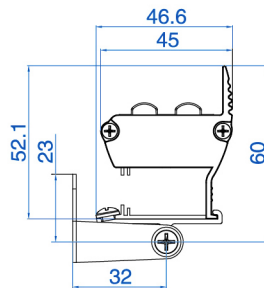

Applications

- Wall washer for building, bridge
- Park, plaza steps lighting
- River way, bridge guardrail lighting
- Airport, subway, overpass, landmark lighting
- Inner wall washer of building
- Individual building, architecture group lighting

Specific Parameters

Product Model	Type	Control Method		Voltage	Power	Detailed Introduction
OK-BT-40-CL-CJ	DIP	Normally on		24V	15.36W	192Pcs LED Bulbs, Single Color: R,G,B,Y,W,BG,SKY,GLD
OK-BT-40-CX1-1S-CJ	DIP	Serial control Single Signal Line	Digital single color	24V	15.36W	192Pcs LED Bulbs, Single Color: R,G,B,Y,W
OK-BT-40-CX1-1S-TP	SMD			24V	17.28W	Single Color (72 Pcs 5050SMD 3 in 1)
OK-BT-40-CX1-3S-CJ	DIP		Digital RGB	24V	17.28W	R72G72B72
OK-BT-40-CX1-3S-TP	SMD		24V	17.28W	RGB(72 Pcs 5050SMD 3 in 1)	

OK BTG-18 LED Ultra High Wall Washer (Built in Double Protection XTG-18 Linear Light Source)

CE FC IP68 Patented Product

Model: OK-BTG-18



Product Size (mm)

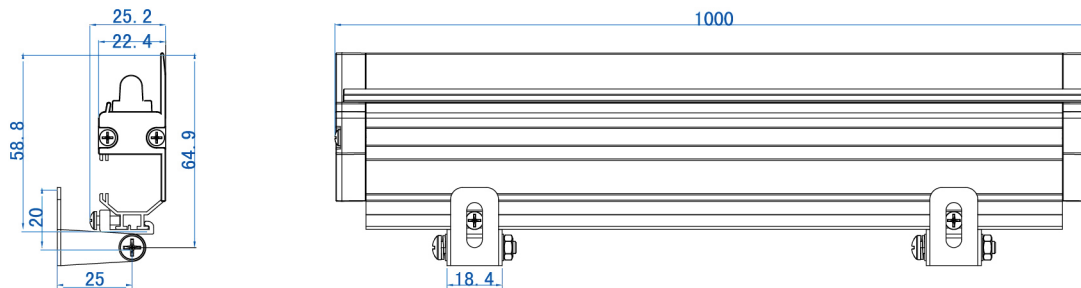

Applications

- ⦿ Wall washer for building, bridge
- ⦿ Park, plaza steps lighting
- ⦿ River way, bridge guardrail lighting
- ⦿ Airport, subway, overpass, landmark lighting
- ⦿ Inner wall washer of building
- ⦿ External perspective-lights inside of the building
- ⦿ Outdoor plaza, landscape lighting

Specific Parameters

Product Model	Type	Control Method	Voltage	Power	Detailed Introduction
OK-BTG-18-CL-CJ	DIP	Normally on	24V	7.68W	96 Pcs LED Bulbs, Single Color: R,G,B,Y,W,BG,SKY,GLD

OK BTG-25 LED Ultra High Wall Washer (Built in Double Protection XTG-25 Linear Light Source)

CE FC IP68 Patented Product

Model: OK-BTG-25



Product Size (mm)

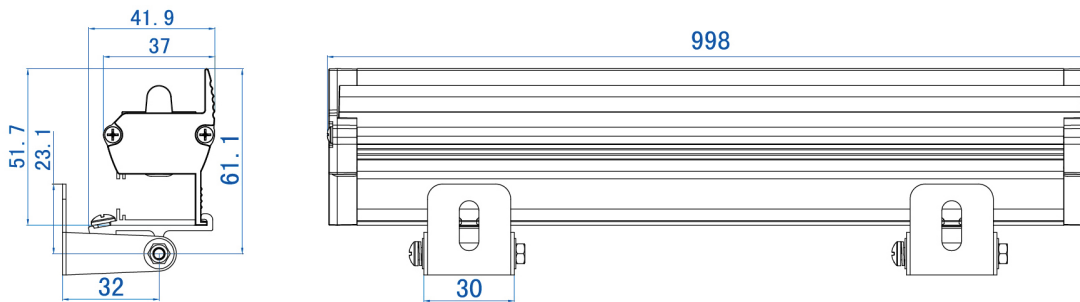

Applications

- Wall washer for building, bridge
- Park, plaza steps lighting
- River way, bridge guardrail lighting
- Airport, subway, overpass, landmark lighting
- Inner wall washer of building
- External perspective-lights inside of the building

Specific Parameters

Product Model	Type	Control Method		Voltage	Power	Detailed Introduction
<i>OK-BTG-25-CL-CJ</i>	DIP	Normally on		24V	7.68W	96Pcs LED Bulbs, Single Color: R,G,B,Y,W,BG,SKY,GLD
<i>OK-BTG-25-CL-CJ</i>	DIP			24V	11.52W	144Pcs LED Bulbs, Single Color: R,G,B,Y,W,BG,SKY,GLD
<i>OK-BTG-25-CX1-1S-CJ</i>	DIP	Serial control Single Signal Line	Digital single color	24V	7.68W	96Pcs LED Bulbs, Single Color: R,G,B,Y,W
<i>OK-BTG-25-CX1-3S-CJ</i>	DIP		Digital RGB	12V	8.64W	R36G36B36

OK BTG-40 LED Ultra High Wall Washer (Built in Double Protection XTG-40 Linear Light Source)

CE FC IP68 Patented Product

Model: OK-BTG-40



Product Size (mm)

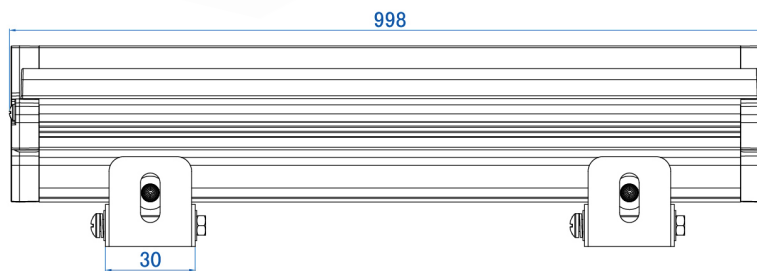
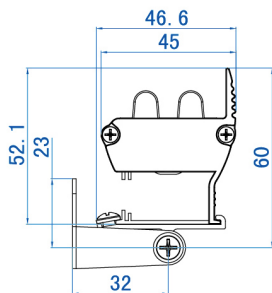

Applications

- Wall washer for large scale building, bridge
- Park, plaza steps lighting
- River way, bridge guardrail lighting
- Airport, subway, overpass, landmark lighting
- Inner wall washer of building
- External perspective-lights inside of the building
- Outdoor plaza, landscape lighting

Specific Parameters

Product Model	Type	Control Method		Voltage	Power	Detailed Introduction
OK-BTG-40-CL-CJ	DIP	Normally on		24V	15.36W	192Pcs LED Bulbs, Single Color: R,G,B,Y,W,BG,SKY,GLD
OK-BTG-40-CX1-1S-CJ	DIP	Serial control Single Signal Line	Digital single color	24V	15.36W	192Pcs LED Bulbs, Single Color: R,G,B,Y,W
OK-BTG-40-CX1-3S-CJ	DIP		Digital RGB	24V	17.28W	R72G72B72

OK BTG-50G LED Ultra High Wall Washer (Built in Double Protection XTG-50G Linear Light Source)

CE FC IP68 Patented Product

Model: OK-BTG-50G



Product Size (mm)

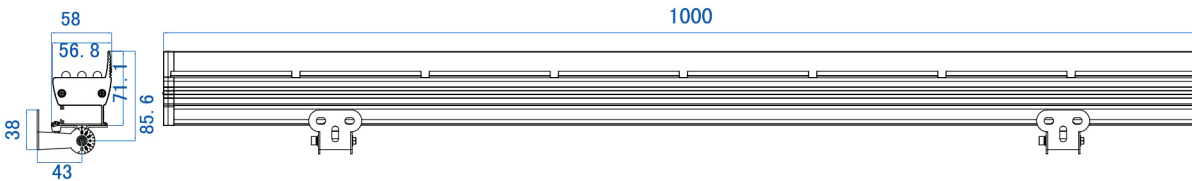

Applications

- Wall washer for building and bridge
- Park, plaza steps lighting
- Airport, subway, overpass, landmark lighting
- Inner wall washer of building
- External perspective-lights inside of the building
- River way, bridge guardrail lighting
- Swimming pool fountain

Specific Parameters

Product Model	Type	Control Method		Voltage	Power	Detailed Introduction
<i>OK-BTG-50G-CL-CJ</i>	DIP	Normally on		24V	24W	288Pcs LED Bulbs, Single Color: R,G,B,Y,W,BG,SKY,GLD
<i>OK-BTG-50G-CX1-1S-CJ</i>	DIP	Serial control Single Signal Line	Digital single color	24V	24W	288Pcs LED Bulbs, Single Color: R,G,B,Y,W
<i>OK-BTG-50G-CX1-3S-CJ</i>	DIP		Digital RGB	24V	24W	R96G96B96

OK BTG-60 LED Ultra High Wall Washer (Built in Double Protection XTG-60 Linear Light Source)

CE FC IP68 Patented Product

Model: OK-BTG-60

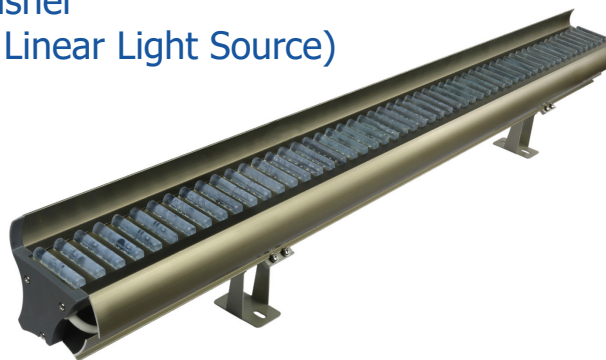

Product Size (mm)

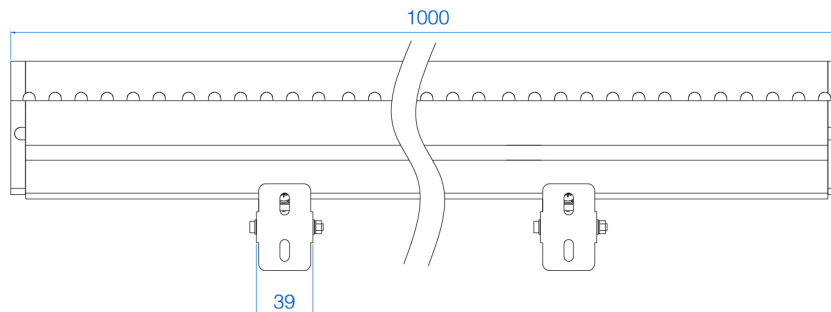
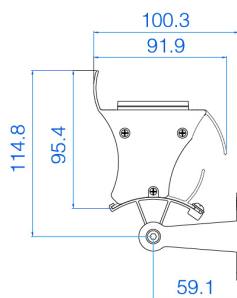

Applications

- Wall washer for building and bridge
- Park, plaza steps lighting
- Airport, subway, overpass, landmark lighting
- Inner wall washer of building
- External perspective-lights inside of the building
- River way, bridge guardrail lighting
- Swimming pool fountain

Specific Parameters

Product Model	Type	Control Method		Voltage	Power	Detailed Introduction
<i>OK-BTG-60-CL-CJ</i>	DIP	Normally on		24V	25W	324Pcs LED Bulbs, Single Color: R,G,B,Y,W,BG,SKY
<i>OK-BTG-60-CX1-1S-CJ</i>	DIP	Serial control Single Signal Line	Digital single color	24V	25W	324Pcs LED Bulbs, Single Color: R,G,B,Y,W
<i>OK-BTG-60-CX1-3S-CJ</i>	DIP		Digital RGB	24V	25W	R108G108B108

OK BTG-45 LED High-power Wall Washer (Built in LED High-power Point Light Source)

CE FC IP68 Patented Product

Model: OK-BTY-45



Product Size (mm)

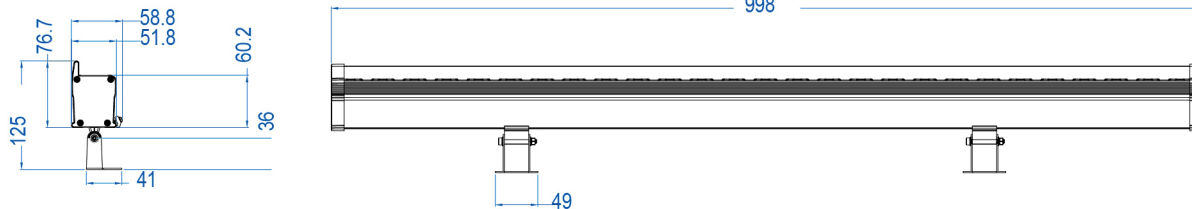

Applications

- Wall washer for building, bridge
- River way, bridge guardrail lighting
- Airport, subway, overpass, landmark lighting
- External perspective-lights inside of the building
- Outdoor plaza, landscape lighting

Specific Parameters

Product Model	Type	Control Method	Voltage	Power	Detailed Introduction
OK-BTY-45-CL-TP	TP	Normally on	36V	27W	each meter contains 27 pcs waterproof high power point light source



OK Double Protection LED Bridge Light



Bridge Light



OK-QL-42



OK-QL-52



OK-QL-86

Product size: mm

OK Double Protection LED Wall Washer Light Technical Parameters

Production Technology: Double Protection

Average Lifespan: 50000hrs

Electrical Safety Class: III Class

Outdoor Weather Resistant: 10years

Outer Shell Fireproof Grade: V-0

Working Temperature: -20 °C -55 °C

Protect Grade: IP68

OK Double Protection LED Wall Washer Light Product Analysis

OK LED Bridge light with integrative design could have the wall washer and outline drawing function at the same time. The bridge lights could be controlled individually to satisfy the energy saving purpose in different period.

OK QL-42 LED Bridge light (Aluminum outer shell)

CE FC IP68 Patented Product

Model: OK-QL-42



Product Size (mm)

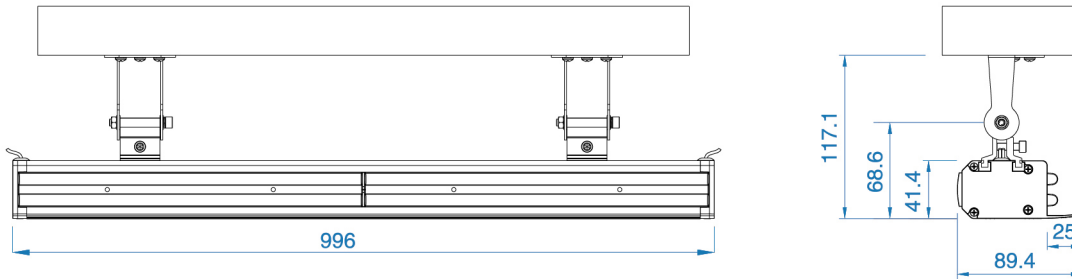

Applications

- ⊙ Wall-washing for bridge and building
- ⊙ River-way, river wall, bridge guardrail lighting
- ⊙ Airport, subway, viaduct, overpass, landmark lighting
- ⊙ Individual building, architectural complex lighting
- ⊙ Building roof decoration

Specific Parameters

Product Model	Type	Control Method		Voltage	Power	Detailed Introduction
OK-QL-42	DIP	Normally on		24V	15.36W	192Pcs LED Bulbs, Single Color: R,G,B,Y,W,BG,SKY,GLD
	/				/	/
	SMD				7.68W	96Pcs 3528 SMD

OK QL-52 LED Bridge light (Aluminum outer shell)

CE FC IP68 Patented Product

Model: OK-QL-52



Product Size (mm)

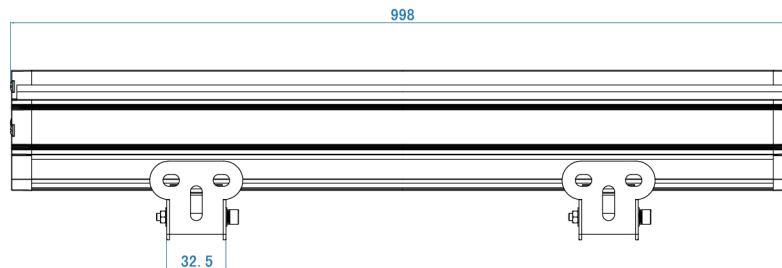
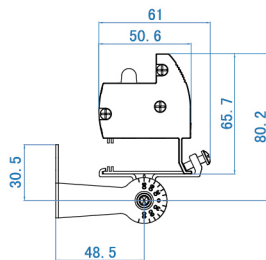

Applications

- ⦿ Bridges (Such as overpasses, steel bridge)
- ⦿ River channel

Specific Parameters

Product Model	Type	Control Method		Voltage	Power	Detailed Introduction
OK-QL-52	DIP	Normally on		24V	7.68W	96Pcs LED Bulbs, Single Color: R,G,B,Y,W,BG,GLD
	/	/		/	/	/
	SMD	Serial control Single Signal Line	Digital RGB	12V	8.64W	RGB(36Pcs 5050 SMD 3 in 1)
	DIP	Normally on		24V	7.68W	96Pcs LED Bulbs, Single Color: R,G,B,Y,W,BG,SKY,GLD
	SMD					96Pcs 3528 SMD



OK Double Protection LED Underground Light

OK Double Protection LED Underground Light Technical Parameters

Production Technology: Double Protection

Electrical Safety Class: III Class

Outer Shell Fireproof Grade: V-0

Protect Grade: IP68

Average Lifespan: 50000hrs

Outdoor Weather Resistant: 10years

Working Temperature: -20℃ -55℃

Luminous Angle: 120°-180°

OK Double Protection LED Underground Light Product Analysis

Has been produced based on patent technology double protection encapsulation and reaches highest protect grade IP68. It is widely applied to underground lighting of square, park etc.

OK XT50 Underground LED Light (Built in Double Protection XT-25DM Linear Light Source)

CE FC IP68 Patented Product

Model: OK-DM-XT50

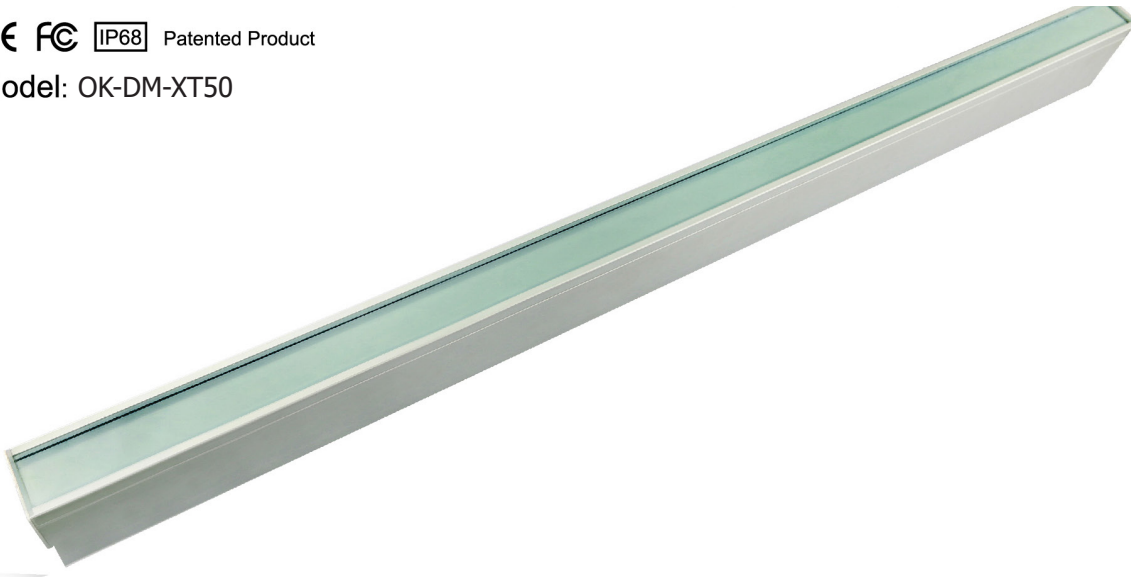

Product Size (mm)

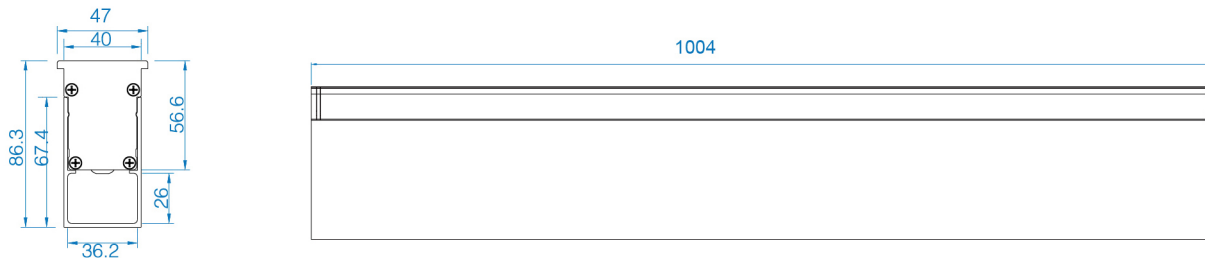

Applications

- ⦿ Underground lighting of square
- ⦿ Underground lighting of park

Specific Parameters

Product Model	Type	Control Method	Voltage	Power	Detailed Introduction
OK-DM-XT50-CL-CJ	DIP	Normally on	24V	7.68W	96Pcs LED Bulbs, Single Color: R, G, B, Y, W



LED Control System

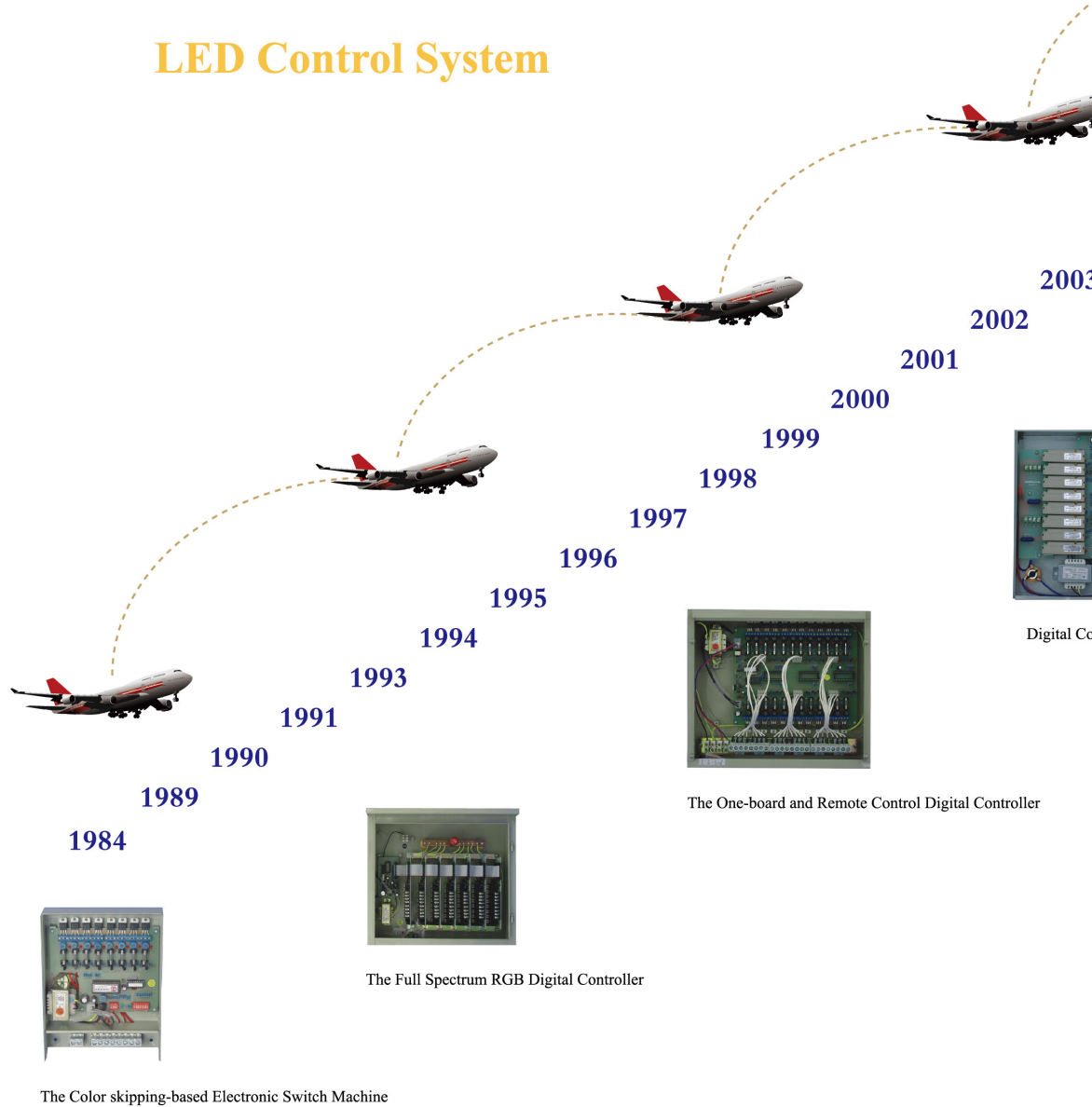



Control Machine

1. II Type LED Control System

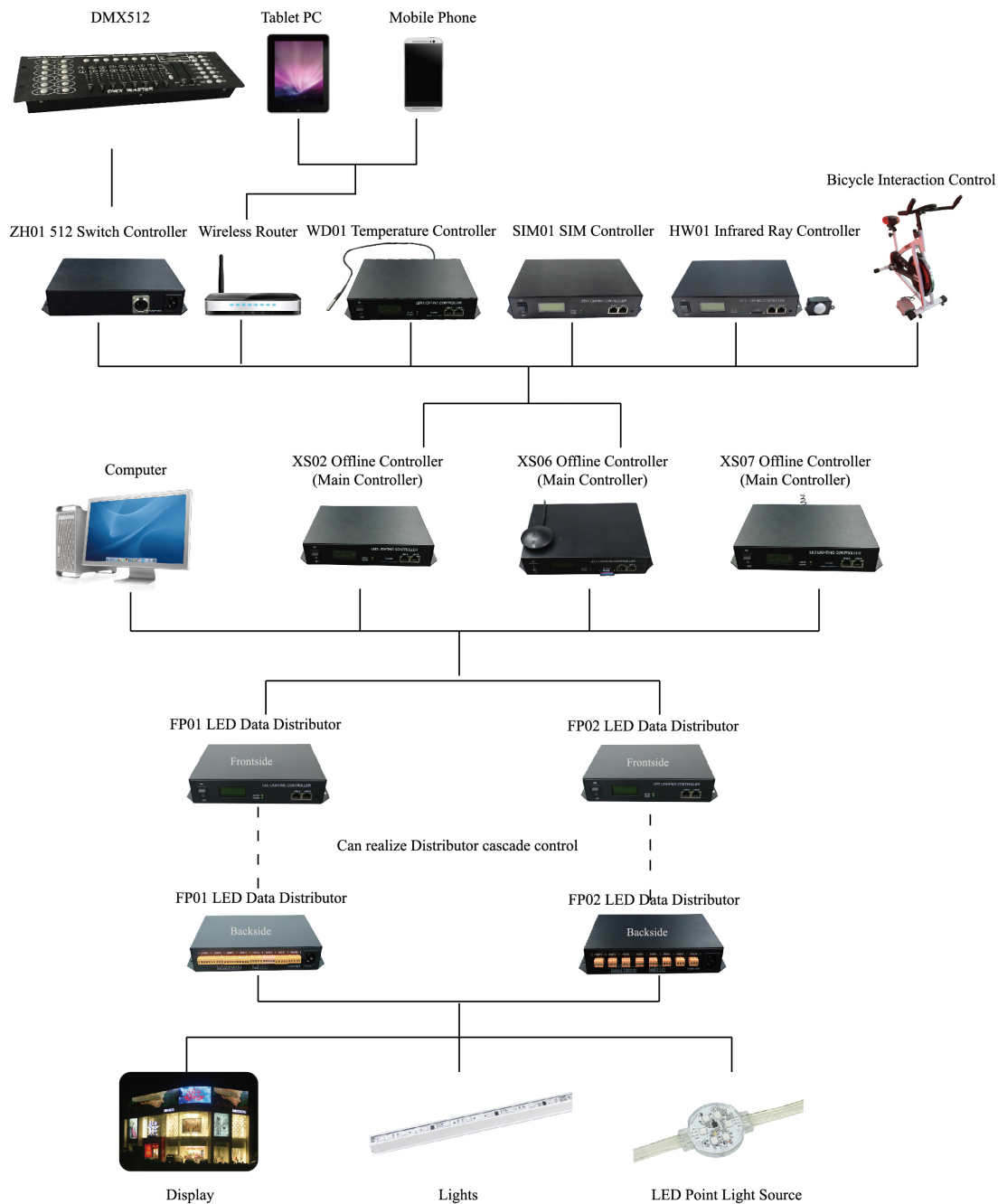

XS03 Single Machine Controller
(Single Controller)



XS04 Single Machine Controller
(Single Controller)



XS05 Single Machine Controller
(Single Controller)



Display



Lights



LED Point Light Source

2. This LED Control System is Signal Control System. It has 3 kinds of Control Mode: Single Machine Controller Mode; Offline Mode; Online Mode (PC Connection Method/Synchronized)

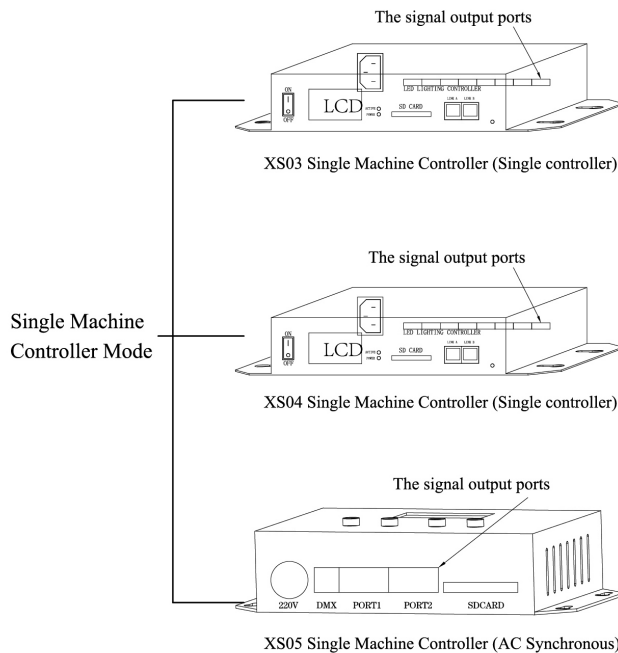

Single Machine Controller Mode Instruction:

XS03 and XS04 are single machine controllers, can be used with single one. XS03-Single controller: applies to light source of serial control. XS04-Single controller: applies to light source of DMX512 protocol.

XS05 Single Machine Controller can be used many single one together, can realize the AC Synchronous function when power on them at the same time. XS05-Single controller: contains two ports of serial control and one port of DMX512 protocol.

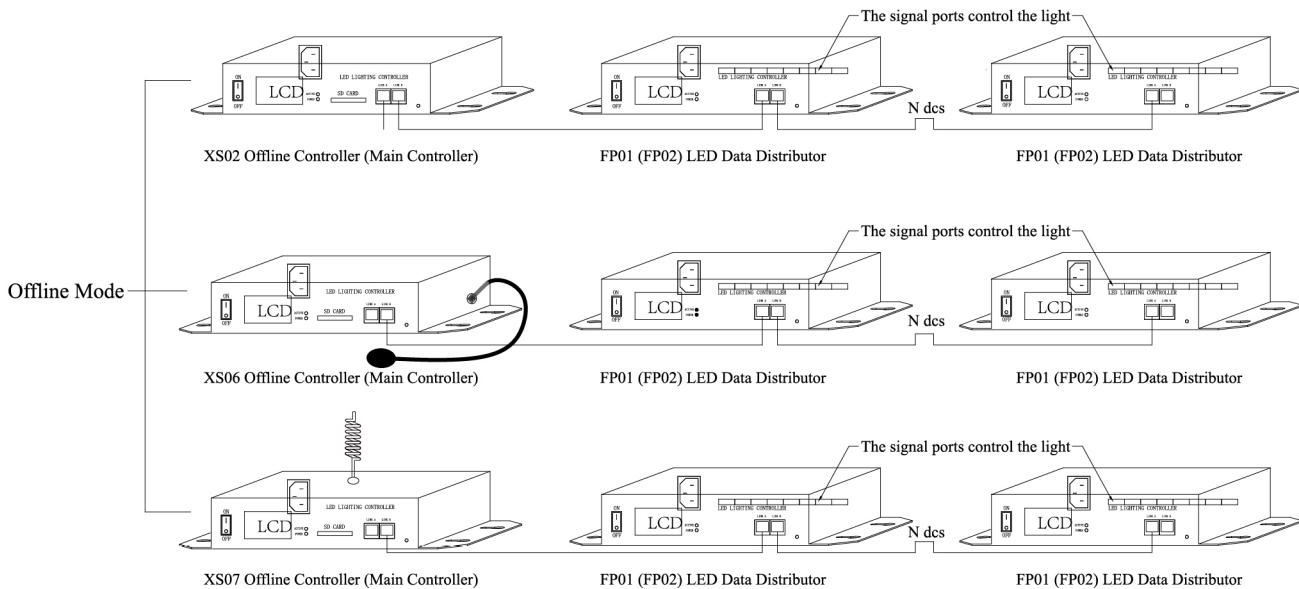

Offline Mode Instruction:

1), Offline Controller (Main Controller) and Data distributor should be connected by cross ruling, i.e., one end is 568A, and the other end is 568B. Normally use the Cat5e Net Cable, less than 100m, if with the long distance, can be cascaded by No-load controller and switch, if with longer distance, can use fiber optic technology.

Order of Network Cables (Front face: From left to Right)

568A: Green white, Green, Orange white, Blue, Blue white, Orange, Brown white, Brown

568B: Orange white, Orange, Green white, Blue, Blue white, Green, Brown white, Brown

2), Data distributor and data distributor should be connected by cross ruling, i.e., one end is 568A, and another end is 568B. Normally use the Cat5e net cable, less than 100m, if with the long distance, can be cascaded by No-load controller and switch, if with longer distance, can use fiber optic technology.

3), The Offline Mode of XS02, XS06, XS07 Offline Controller (Main Controller) and Data distributor can load at most 120,000pcs lights.

4), FP01-Distributor: applies to light source of serial control, FP02-Distributor: applies to light source of DMX512 protocol.

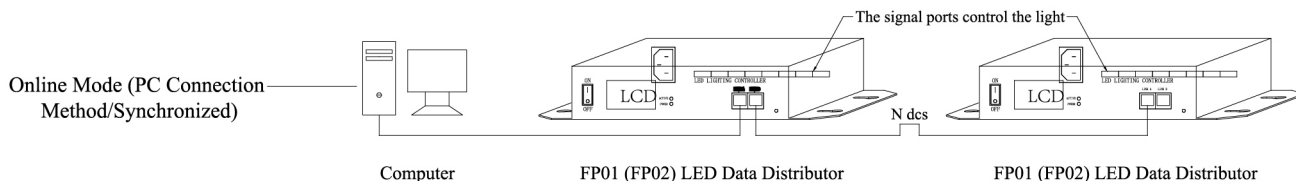

3.OK Landscape Illumination Internet Long-range control and Management system

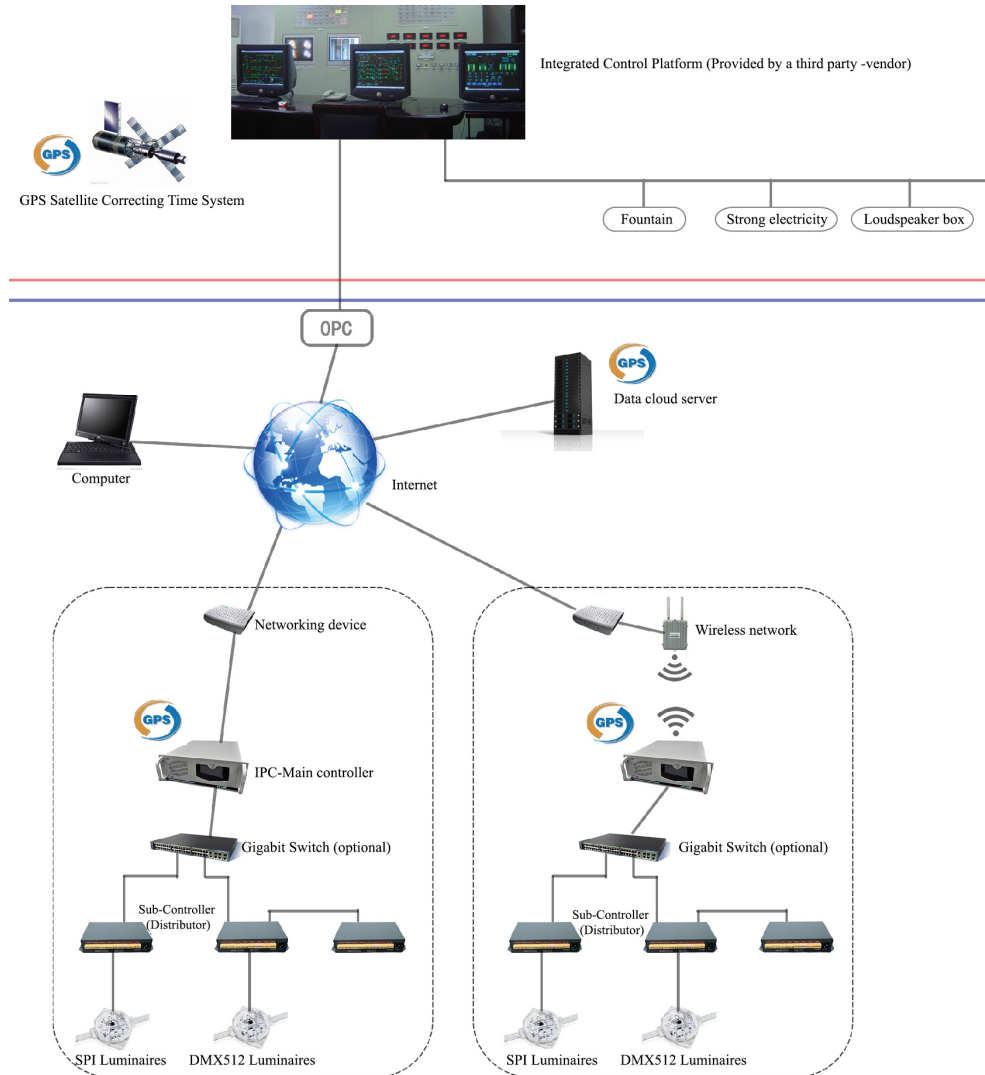

The Long-range control and management system of internet-based TCP/IP protocol which researched and developed by OK Company is to realize synchronous linkage among landscape illumination projects in different places and achieve a splendid city lighting effect, its long-range management unit could manage a whole project all-around by accessing to internet in any place. OK lighting control system server can offer OPC interface, which realizes the accuracy control of lighting system by integrated control platform, the server and each IPC use the GPS satellite correcting time system to ensure the unification of the whole system time.

When the lights in single IPC are less than 120,000pcs, it doesn't need the interchanger, but when more than 1 million, the system could be extended by the data cloud server.

Sub-controller-Distributor) can load all types luminaire of SPI and standard DMX 512 protocol (it could control by offering the control IC protocol), it could use cascade or star connection way.



Accessories



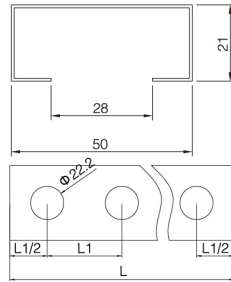

Product Name: Φ20 point light source aluminum track
 Type: Φ20
 Specification: 10 holes/m (can be customized)
 Hole size: Φ22.2

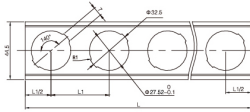
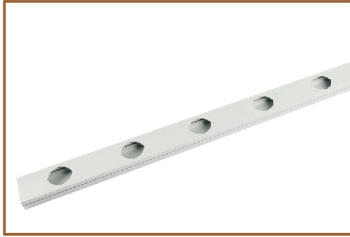

Product Name: Φ30 point light source aluminum track
 Type: Φ30-1
 Specification: 10 holes/m (can be customized)
 Hole size: Φ27.52⁰_{-0.1} (inner diameter) Φ32.5 (external diameter)

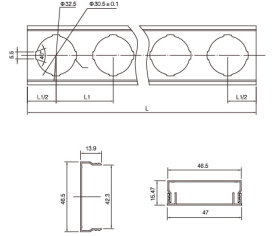
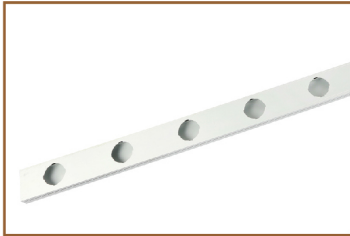

Product Name: Φ30 point light source aluminum track
 Type: Φ30-2
 Specification: 10 holes/m (can be customized)
 Hole size: Φ30.5 ± 0.1 (inner diameter) Φ32.5 (external diameter)

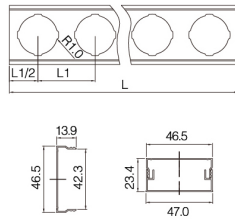

Product Name: Φ30 point light source aluminum track
 Type: Φ30-3
 Specification: 10 holes/m (can be customized)
 Hole size: Φ30.9⁰_{-0.1} (inner diameter) Φ32.5 (external diam)

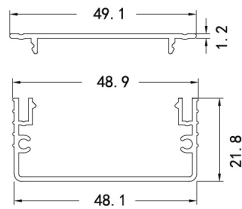

Product Name: Φ30 point light source aluminum track
 Type: Φ30-3
 Specification: 10 holes/m (can be customized)
 Hole size: Φ30.6mm

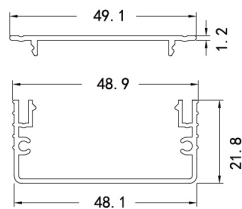

Product Name: Φ30 point light source aluminum track
 Type: Φ30-3
 Specification: 10 holes/m (can be customized)
 Hole size: Φ30.6mm

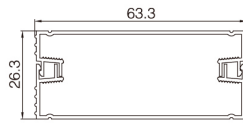
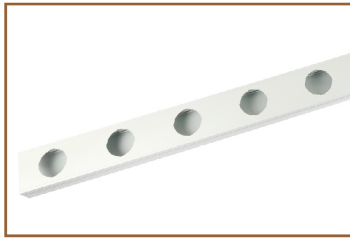

Product Name: Φ40 point light source aluminum track
 Type: Φ40-1
 Specification: 10 holes/m (can be customized)
 Hole size: Φ40.5(inner diameter) Φ42(external diameter)

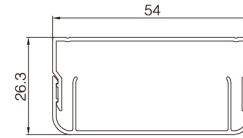
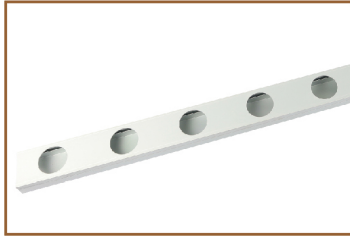
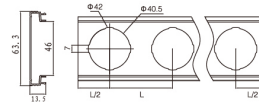

Product Name: Φ40 point light source aluminum track
 Type: Φ40-2
 Specification: 10 holes/m (can be customized)
 Hole size: Φ40.5(inner diameter) Φ42(external diameter)

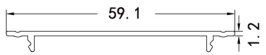
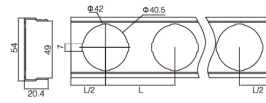

Product Name: Φ40 point light source aluminum track
 Type: Φ40-3
 Specification: 10 holes/m (can be customized)
 Hole size: Φ40.5mm

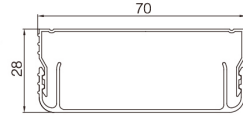
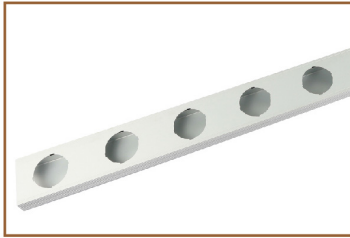
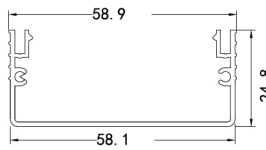

Product Name: Φ50
 Type: Φ50
 Specification: 10 holes/m (can be customized)
 Hole size: Φ47.6⁰_{-0.1}

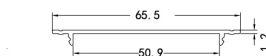
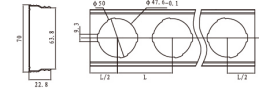

Product Name: Φ50 point light source aluminum track
 Type: Φ50-3
 Specification: 10 holes/m (can be customized)
 Hole size: Φ47.5mm

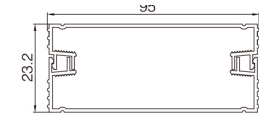
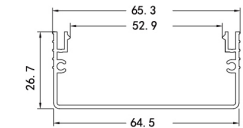

Product Name: Φ60 point light source aluminum track
 Type: Φ60
 Specification: 10 holes/m (can be customized)
 Hole size: Φ60.1⁰_{-0.1}(inner diameter) Φ62.5(external diameter)

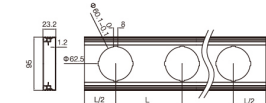

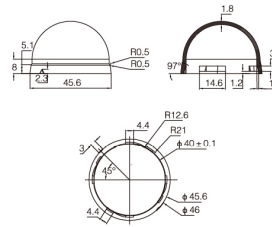

Product Name: 40 Point Light Source Cover
Item No.: OKQF-052

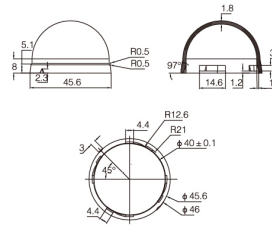

Product Name: 50 Point Light Source Cov
Item No.: OKQF-052

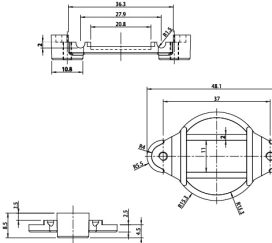

Product Name: The steel base
Item No.: OKQF-084
Specification: Plastic

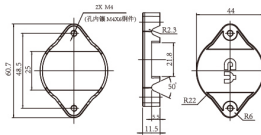

Product Name: The steel base for 40 LED Lights
Item No.: OKQF-048
Specification: Plastic

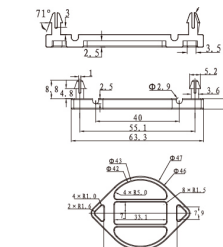

Product Name: The steel base for 50 LED Lights
Type: OKQF-051
Specification: Plastic

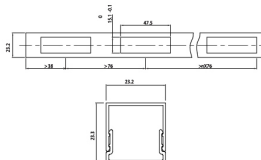

Product Name: 16X60 LED Square Light Source
Type: 16X60
Specification: 10 holes/m (can be customized)
Hole size: Φ 48.5mm

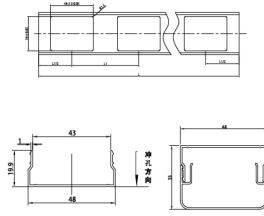

Product Name: 50X40 LED Square Light Source
 Type: 50X40
 Specification: 10 holes/m (can be customized)
 Hole size: $\Phi 48.5\text{mm}$

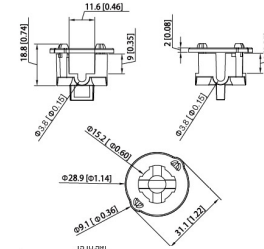
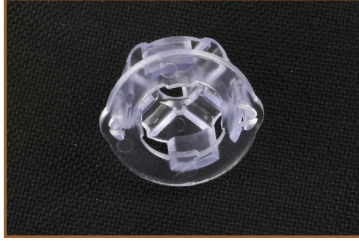

Product Name: $\Phi 15$ LED mesh screen fixing part
 Application: $\Phi 15$ LED point light
 Overall Size: $\Phi 28.9\text{mm} \times 25.6\text{mm}$
 Raw Material: plastic

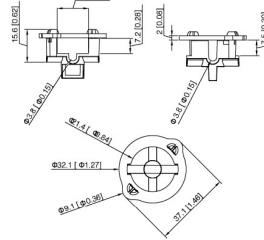

Product name: $\Phi 20$ LED mesh screen fixing part (underground)
 application: $\Phi 20$ LED point light (underground)
 Overall Size: $\Phi 32.1\text{mm} \times 23.3\text{mm}$
 Raw Material: plastic

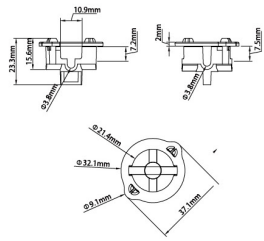
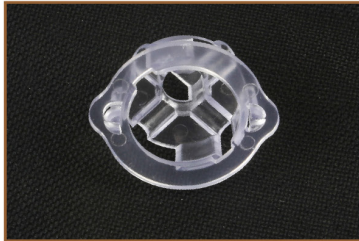

Product name: $\Phi 20$ LED mesh screen fixing part
 application: $\Phi 20$ LED point light
 Overall Size: $\Phi 32.1\text{mm} \times 23.3\text{mm}$
 Raw Material: plastic

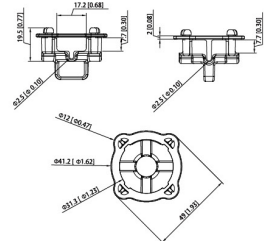
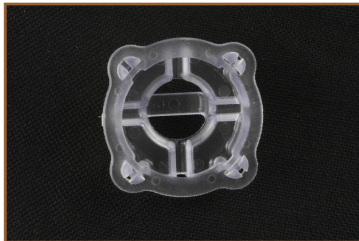

Product name: $\Phi 30$ LED mesh screen fixing part
 application: $\Phi 30$ LED point light
 Overall Size: $\Phi 41.2\text{mm} \times 30\text{mm}$
 Raw Material: plastic

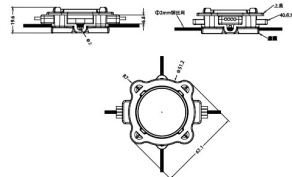
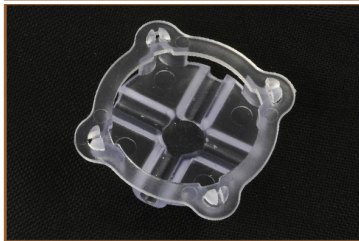

Product name: $\Phi 40$ LED mesh screen fixing part
 application: $\Phi 40$ LED point light
 Overall Size: $\Phi 51.2\text{mm} \times 19.6\text{mm}$
 Raw Material: plastic

OK Double Protection LED Point Light Source Installation Method

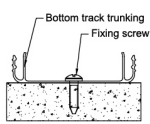

Picture 1

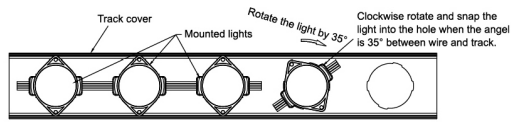

Picture 2

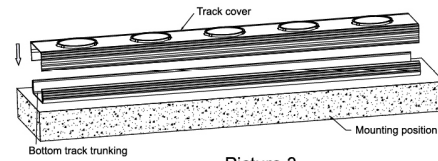

Picture 3

A. Mounted by special aluminum alloy track

1. First install the bottom aluminum base, please check the picture 1.
2. Insert the point light into the aluminum track (make 35° between the extrusion wire of light and the track and then turn the lights.) Please check the picture 2.
3. insert the top cover to the bottom base. Please check the picture 3.

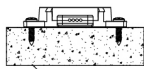

Picture 4

B. Mounted by screws directly

1. Install the lights with screws. Please check the picture 4.

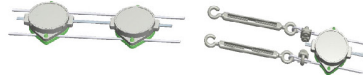

Picture 5



Picture 7



Picture 6



Picture 8



Picture 9

C. Mounted by steel wire Rope cable

1. Fix the LED point lights and its base to the steel wire, keep two steel wires straight and parallel during the installation. (check the picture 5)
2. After finishing the base and lights installation, then mount a steel wire rope tensioning devices at two ends of the wire (check the picture 6). Keep two steel wires with the same length, the fixing way of steel wire rope tensioning devices, please check the picture 7 and 8.
3. Finally, Mounted the steel wire at the actual project, the detailed installation way can be considered at the site situation. (check the Picture 8), the tensioning devices can be adjusted till the whole steel wire in a straight line. (check the Picture.9)

okvolight



A night sky with a starry background and a glowing horizon line, with the text 'okvolight' centered in the foreground.

okvolight