

AXP FLATY 6060 SURFACE

Backlight Series | Basic LED Panel Luminaires

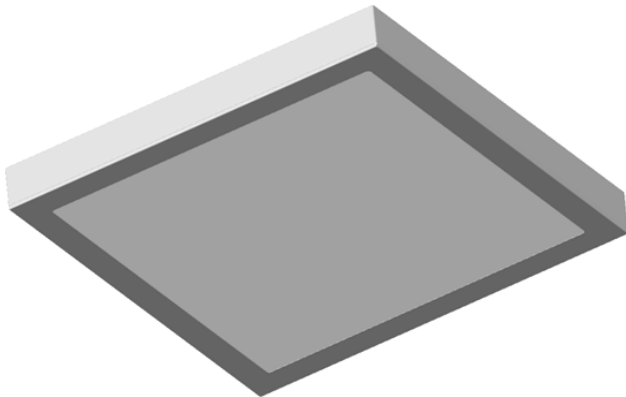

Areas of application

- Hotels, Shops and Shopping Centers,
- Museums, Exhibitions, Conferences and Ballrooms
- Business Centers, Offices and Corridors,
- Halls, Living Rooms and Living Areas
- Schools, Hospitals and Public Institutions
- Prefabricated and Modular Campuses

Products benefits

- The possibility of using three white colors in the same product
- Quick , simple and safe replacement without rewiring
- Low maintenance costs thanks to long lifetime
- Instant-on light , therefore ideally suitable in combination with sensor technology
- Correct operation even at low temperature

Product features

- Design: Ceiling LED luminaires with metal frame in high value design
- Color Temperature: 2700 - 3000 K (Warm White) , 4000 - 4750 K (Natural White) or 6500-7000 K (Cool White)
- Mounting Type: Drywall mounting
- Type Of Protection: IP40
- Lifetime: up to 50,000h
- Warranty Time: 2 Years min.

Technical Data

Electrical Data

Nominal input wattage (AC)	33 W
Lamp output wattage (DC)	28.7 W
Nominal input voltage	220 V AC
Nominal input frequency	50/60 Hz
Nominal input current	0.15 A
Driver efficiency	85-90 %
LED forward current	50 mA
Power Factor λ	≥ 0.90
Output current tolerance	$\pm 5 \%$

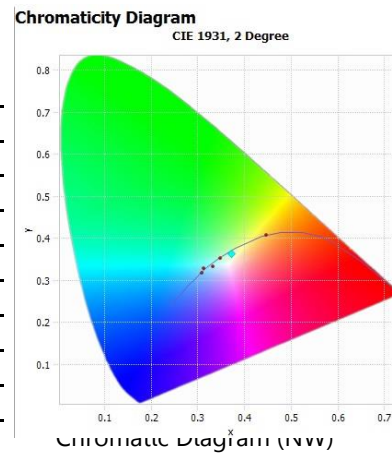

Phometrical Data

Color temperature	2700 - 3300 K	4000 - 4750 K	6500 - 7000 K
Luminous flux	2900 - 3000 lm	3200 - 3400 lm	3150 - 3250 lm
Light color (Destination)	WW	NW	CW
Color rendering index Ra	> 80 - 85	> 85 - 90	> 82 - 87

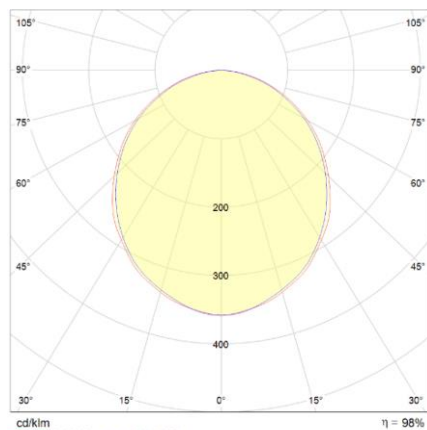

Polar Graph for Naturel White Color

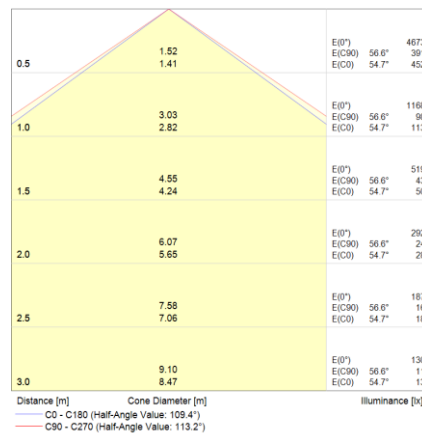

Conic Graph for Naturel White Color

Light technical data

Beam angle	Extremely wide distribution, 120°
Light distribution	Symmetric

Temperatures

Operating Temperature	-20...+50 °C
Storage Temperature	-30 / +60

Materials

Body material	Sheet Metal
Body color	Ral 9016 bright
Cover material	Sheet Metal
Cover color	Ral 9016 texture matte/Optional

Capabilities

Type of connection	Cable & connector
Color change	3 in 1, manuel
DALI control	Optional
Dimmable	Optional
Emergency lighting kit	Optional

Additional product data

Diffuser material	Polystyrene
Diffuser efficiency	80%-86%
Diffuser type	Single ragged surface

Certificates & Standarts

IEC Protection class	Class I
Ingress Protection Rating	IP40
Standarts	TS EN 60598-2-2 , TS EN 60598-1 , TS EN 62471 , TS EN 13032-1 , TS EN 62031
Certificates	CE , TSE

Model Options

MODEL	CODE	COLOR MODE	COLOR	LUMEN	CRI	LED
BRONZE	AXP.FLT.6060.SVU.BNZ	1	WW/NW/CW	3300lm	Ra> 80	PLESSEY
SILVER	AXP.FLT.6060.SVU.SLV	1	WW/NW/CW	3400lm	Ra> 85	OSRAM
GOLD	AXP.FLT.6060.SVU.GLD	3	WW-NW-CW	3300lm	Ra> 80	PLESSEY
PLATINUM	AXP.FLT.6060.SVU.PLT	3	WW-NW-CW	3400lm	Ra> 85	OSRAM
DIAMOND	AXP.FLT.6060.SVU.DMD	3	WW-NW-CW	3500lm	Ra> 85	OSRAM

Dimensions & Weight

Length (L)	600 mm
Width (W)	600 mm
Height (H)	70 mm
Product weight	4.5 kg
Mounting hole length (L1)	540mm
Mounting hole width (W1)	375mm
Mounting type	Surface mounting

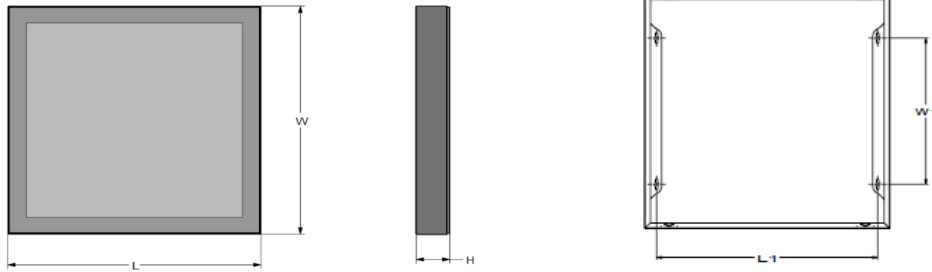

Logistical data

Product code	Product description	Single Packaging Dimensions (L x W x H)	Single Packaging Volume (dm3)	Single Packaging Gross Weight	Multi Packaging unit	Multi Packaging Dimensions (L x W x H)	Multi Packaging Volume (dm3)	Multi Packaging Gross Weight
	BASIC SURFACE	620x620x90 mm	10,8	5,4 kg	30 pcs	80x120x136 cm	1349,12	163 kg

The mentioned product code describes the smallest quantity unit which can be ordered. One shipping unit can contain one or more single products. When placing an order, for the quantity please enter single or multiples of a shipping unit.

References / Links

Driver OSRAM
-Osram Driver Datasheet

Disclaimer

Subject to change without notice. Errors and omission excepted. Always make sure to use the most recent release.

PCB data

Material	FR4 single layer
Material thickness	1.2 mm
Copper road thickness	25 μ m
Schematic design	

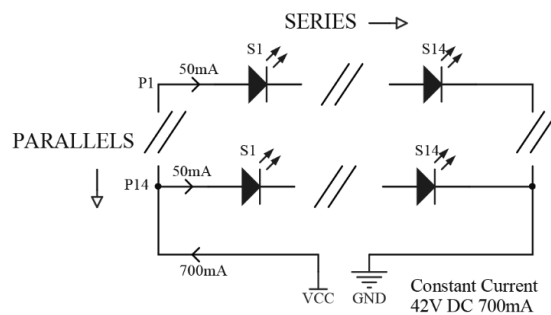

Spectrometrical data

a.Warm White Platinum

Chromaticity Diagram

CIE 1931, 2 Degree

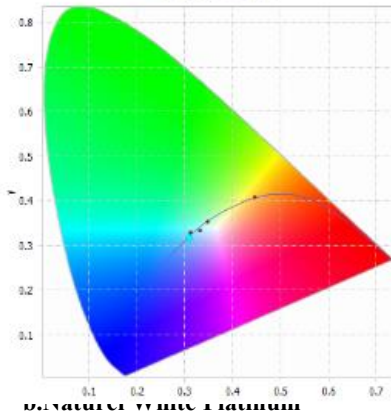

a.Warm White Gold

Chromaticity Diagram

CIE 1931, 2 Degree

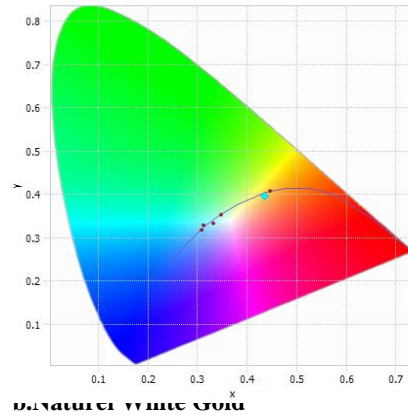

Chromaticity Diagram

CIE 1931, 2 Degree

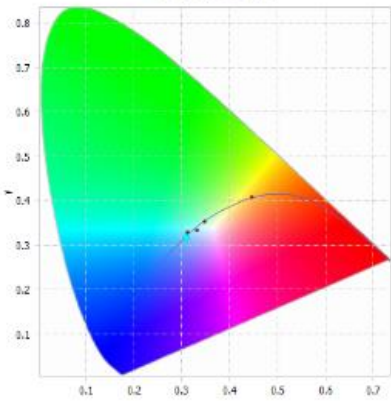

Chromaticity Diagram

CIE 1931, 2 Degree

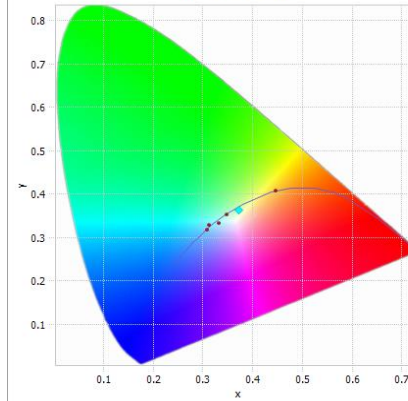

c.Cool White Platinum

Chromaticity Diagram

CIE 1931, 2 Degree

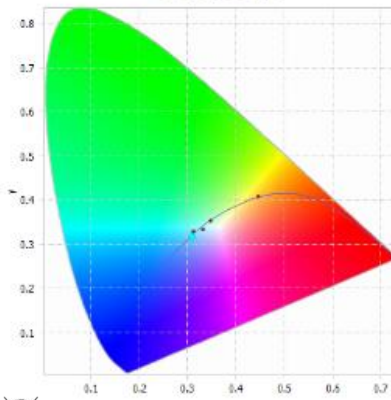

c.Cool White Gold

Chromaticity Diagram

CIE 1931, 2 Degree

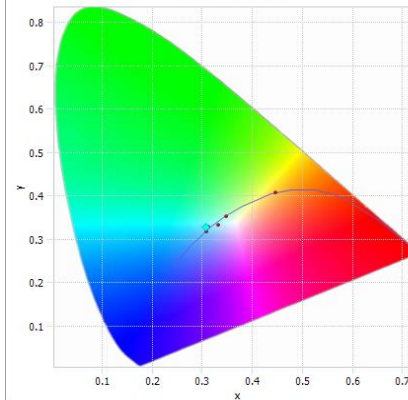

info@okvolight.com